



**EURO – LUCE**

Light Engineering

**#26 - 27**



“The right light  
transforms  
every space”



<b>INBOUWVERLICHTING ÉCLAIRAGE ENCASTRÉ</b>	<b>8</b>
---	----------

<b>OPBOUWVERLICHTING ÉCLAIRAGE APPARENT</b>	<b>58</b>
---	-----------

<b>LEDSTRIP RUBAN LED</b>	<b>93</b>
-------------------------------	-----------

<b>RAILS</b>	<b>115</b>
--------------	------------

<b>LIJNVERLICHTING LIGNE LUMINEUSE</b>	<b>134</b>
--	------------

<b>INDUSTRIEVERLICHTING ÉCLAIRAGE INDUSTRIEL</b>	<b>148</b>
--	------------

















<b>BUITENVERLICHTING ÉCLAIRAGE EXTÉRIEUR</b>	<b>159</b>
--	------------

<b>SPORTVERLICHTING ÉCLAIRAGE DE SPORT</b>	<b>179</b>
--	------------

<b>VERLICHTING OP ZONNE-ENERGIE ÉCLAIRAGE SOLAIRE</b>	<b>185</b>
---	------------

<b>NOODVERLICHTING ÉCLAIRAGE DE SECOURS</b>	<b>187</b>
---	------------

# Legende - Légende

	Dimbaar - Dimmable	<b>AK</b>	Aansluitkabel - Câble de raccordement
	Uren - Heures	<b>AMB</b>	Amber - Ambre
	Straal - Faisceau	<b>AS</b>	Asymmetrisch - Asymétrique
	IP	<b>B</b>	Brood/Kaas - Pain/Fromage
	Afmetingen - Dimensions	<b>BCL</b>	Bevestigingsclip - Clip de fixation
	Driver	<b>BR</b>	Bevestigingsring - Anneau de montage
	Garantie	<b>BT</b>	Bluetooth
	CRI - IRC	<b>C</b>	Controller - Contrôleur
	Kleurtemperatuur - Température de couleur	<b>CCT</b>	gecorrleerde kleurtemperatuur - température de couleur corrélée
	Inbouwdiepte - Profondeur d'encrentrement	<b>CB</b>	Contactblok - Bloc de contact
	EneC	<b>CAS</b>	Casambi
	Light sensor	<b>DA</b>	Dubbel asymmetrisch - Double asymétrique
	Motion sensor	<b>Dali</b>	Digitale adresseerbare verlichtingsinterface - Interface d'éclairage adressable numérique
	Ballproof	<b>Dim</b>	Dimbaar - Dimmable
	Haccp	<b>DK</b>	Dubbelzijdige kleefband - Ruban adhésif double face
	Koude bestendig - Résistant au froid	<b>DMX</b>	Digitaal besturingssysteem voor de aansturing van verlichtingsapparatuur en special effects - Système de commande numérique pour le contrôle des équipements d'éclairage et des effets spéciaux
	Beschikbaar in RAL kleuren - Disponible en couleurs RAL	<b>DN2 -</b>	Twee niveaus met bedieningskabel - Double niveau avec câble de commande
	Wisselend - Variable	<b>DN2 +</b>	Twee niveaus zonder bedieningskabel - Double niveau sans câble de commande
<b>30° L</b>	30° Lens - 30° lentile	<b>DPR</b>	Programmeerbare driver - Driver programmable
<b>60° L</b>	60° Lens - 60° lentile	<b>DRC</b>	Dimming on head
<b>360° S</b>	360° Sensor - 360° Détecteur	<b>DS</b>	Dubbel symmetrisch - Double symétrique
<b>30° V</b>	30° Verdeling - 30° Diffuseur	<b>DT</b>	Dimbare touch - Touche dimmable
<b>60° V</b>	60° Verdeling - 60° Diffuseur	<b>DTW</b>	Dim naar warm - Dim vers chaud
<b>90° V</b>	90° Verdeling - 90° Diffuseur	<b>EC</b>	Eindstuk - Capuchon de fermeture

<b>EX II</b>	Atex zone 2 - Zone atex 2	<b>P</b>	Profiel - Profil
<b>F</b>	Vis - Poisson	<b>PC</b>	Phase cut
<b>IF</b>	Inbouwframe - Cadre encastré	<b>PM</b>	Prismatisch cover - Prismatique couverture
<b>HK</b>	Hoofdkabel - Câble principal	<b>P/NP</b>	Permanent / niet permanent - Permanent / non permanent
<b>HMCV</b>	Matte cover - Cache très matte	<b>Push</b>	Dimmer met pulseschakelaar - Variateur avec interrupteur à impulsion
<b>HT</b>	Hittebestendig - Résistant à la chaleur	<b>PWM</b>	Pulsbreedtemodulatie - Modulation de largeur d'impulsion
<b>LIJN S</b>	Lijnsensor - Détecteur de ligne	<b>R</b>	Retail - Commerce de détail
<b>M</b>	Vlees - Viande	<b>RG</b>	Ring - Anneau
<b>Man</b>	Manueel dim - Dim manuelle	<b>SL</b>	Licht sensor - Capteur de lumière
<b>MB</b>	Medium beam	<b>SB</b>	Bewegingssensor - Capteur de mouvement
<b>MBG</b>	Montagebeugel - Support de fixation	<b>SD</b>	Staaldraad - Fil d'acier
<b>MCL</b>	Montageclip - Clip de montage	<b>SW</b>	Zacht wit - Blanc doux
<b>MH</b>	Magnetische houder - Support magnétique	<b>TD</b>	Transparante Diffuser - Diffuseur transparent
<b>MPC</b>	Magnetische profielklem - Pince de profil magnétique	<b>TRIAC</b>	Triode voor Wisselstroom - Triode pour courant alternatif
<b>MST</b>	Montageset - Kit de montage	<b>TW</b>	Regelbaar wit - Blanc réglable
<b>MT</b>	Magnetische tape - Bande magnétique	<b>U</b>	Unit - Unité
<b>MV</b>	Montageveer - Ressort de montage	<b>UNB</b>	Ultra narrow beam
<b>NB</b>	Narrow beam	<b>UWB</b>	Ultra wide beam
<b>NOOD</b>	Noodmodule - Module de secours	<b>V</b>	Groenten en fruit - Légumes et fruit
<b>O</b>	Opaal - Opale	<b>VB</b>	Verstelbare beugels - Supports ajustables
<b>OC</b>	Opaal cover - Opale Couverture	<b>VBG</b>	Vloerbeugel - Support de plancher
<b>OF</b>	Opbouwframe - Cadre en saillie	<b>VK</b>	Voedingskabel - Câble de raccordement
<b>O/F</b>	On/Off	<b>WB</b>	Wide beam
<b>OD</b>	Opale direct	<b>ZD</b>	Zwarte diffuser - Diffuseur noir
<b>ODI</b>	Opal direct-indirect		
<b>OST</b>	Ophangset - Kit du suspension		
<b>p</b>	Polig - Pôles		









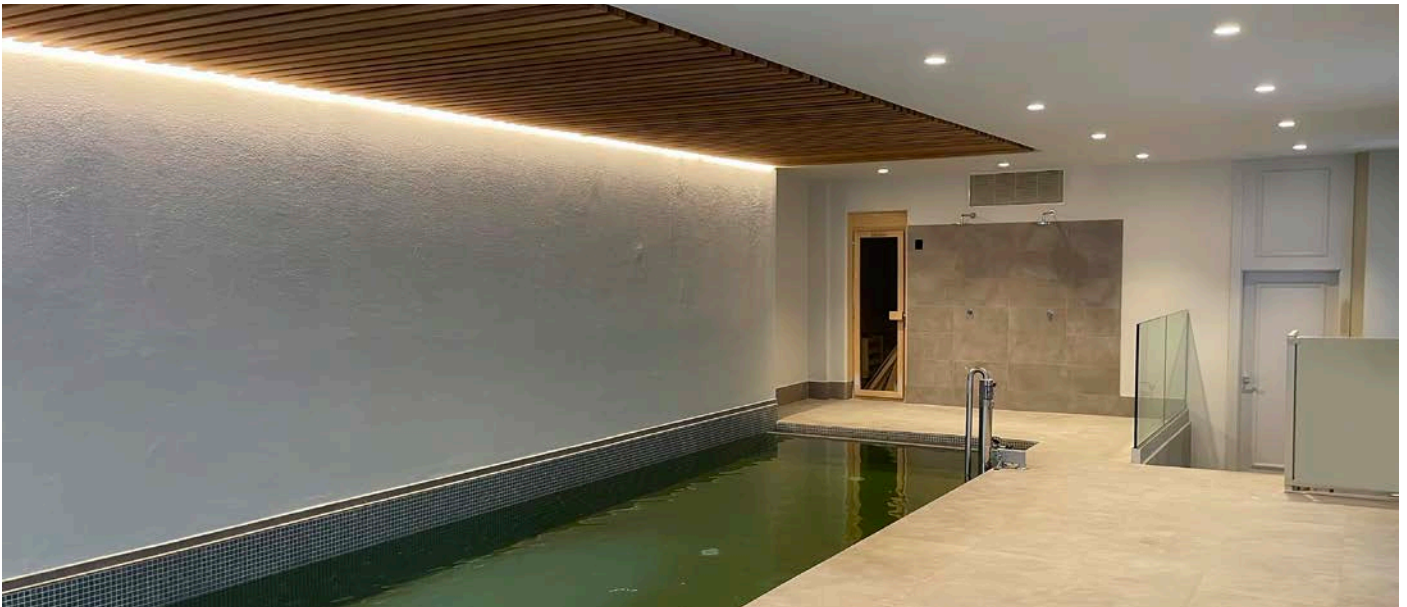







INBOUW  
ENCASTRÉ







## VIENNA 2



















		O/F		Excl.
		40.000h		3
		24°		92
		IP 44		2700K - 3000K
		22mm H 32mm		19

HOF110400112		2W	24°	160 lm	930	
HOF110400212		2W	24°	140 lm	930	
<b>Driver</b>						
HOF430431101	On/Off	3W	700mA			

## VIENNA 5-10



		O/F - Dali		Excl.
		40.000h		3
		24°		92
		IP 20		2700K - 3000K
		~mm H ~mm		35/60

HOF110410112	40mm H 61mm	5W	24°	400 lm	930	
HOF110410212		5W	24°	370 lm	930	
HOF110420112	65mm H 89mm	10W	24°	900 lm	930	
HOF110420212		10W	24°	890 lm	930	
<b>Driver</b>						
HOF410696103	Dali	7-29W	150-700mA			
HOF430621101	On/Off	3-22W	500mA			
HOF410691101	On/Off	21W	150-500mA			

## ALGARVE



<input type="checkbox"/>		O/F		Excl.
		40.000h		3
		2 way		85
		IP 65		2700K
		44mm H 27mm		36

HOF140040111

2W 2 way 140 lm 827

### Driver

HOF430431201

On/Off

6W

700mA

HOF430411201

On/Off

1-8W

350mA

## SINTRA



<input type="checkbox"/>		O/F		Excl.
		40.000h		3
		2 way		85
		IP 65		2700K
		50mm H 40mm		34

HOF140030111

1W/2W 2 way 50 lm/ 110 lm 827

### Driver

HOF430431201

On/Off

6W

700mA

HOF430411201

On/Off

1-8W

350mA





## QUITO



		O/F - Dali		Excl.
		50.000h		3
		35°		>90
		IP 54 front		CCT 2700K/3000K/4000K
		50mm H 57mm		42

HOF110450118 5W 35° 330/ 380/ 410 lm 9~

### Driver

HOF410311104	ON/ OFF	2,5 - 6W	250mA	220V
HOF410696102	DALI	8 - 42W	150 - 1050mA	220V

## GRAZ



		O/F - Dali		Excl.
		40.000h		3
		24°		>92
		IP 65		2700K - 3000K
		50mm H 84mm		45

HOF210100111 7W 24° 460 lm 927

HOF210100211 7W 24° 420 lm 927

### Driver

HOF430411102	ON/OFF	6 - 8W	350mA	
HOF410696102	DALI	8 - 42W	150 - 1050mA	220V

## FLAT AR35-LED ROUND



	O/F - 1-10V - Dali		Excl. (pag. 15)
	35.000h L90 B10		3
	52°		>90
	IP 44		3000K - 4000K
	40mm H 14,5mm		35

HA202 025 328 02	2,2W	52°	200 lm	930	
HA202 025 328 03	2,2W	52°	200 lm	940	
HA615 000 301 21			MV		
HA215 300 610 01			AK 1m		
HA215 300 625 01			AK 2,5m		

## FLAT AR45-LED ROUND



	O/F - 1-10V - Dali		Excl. (pag. 15)
	35.000h L90 B10		3
	60°		>90
	IP 44		3000K - 4000K
	50mm H 12,5mm		45

HA202 024 618 12	3,1W	60°	270 lm	930	
HA202 024 618 13	3,1W	60°	270 lm	940	
HA615 000 301 11			MV		
HA215 300 610 01			AK 1m		
HA215 300 625 01			AK 2,5m		

## AR78-LED ROUND



		O/F - 1-10V - Dali		Excl. (pag. 15)
		60.000h L70 B10		3
		80°		98
		IP 44		3000K - 4000K
		90mm H 14mm		78

HA610 014 302 01	7,5W	80°	450 lm	930	
HA610 014 302 03	7,5W	80°	450 lm	930	
HA610 014 302 08	7,5W	80°	450 lm	930	
HA610 014 303 01	7,5W	80°	450 lm	940	
HA610 014 303 03	7,5W	80°	450 lm	940	
HA610 014 303 08	7,5W	80°	450 lm	940	



## FLAT FR55-LED ROUND



		O/F - 1-10V - Dali		Excl. (pag. 15)
		50.000h L70 B10		3
		110°		95
		IP 44		3000K - 4000K
		68mm H 12,5mm		55 - 58mm

HA610 017 820 08	3W	110°	210 lm	930	
HA610 017 820 03	3W	110°	210 lm	930	
HA610 017 830 08	3W	110°	210 lm	940	
HA610 017 830 03	3W	110°	210 lm	940	
HA205 010 215 06				MV	
HA205 010 215 08				MV	
HA215 300 610 01				AK 1m	
HA215 300 625 01				AK 2,5m	

## FLAT FR68-LED ROUND



		O/F - 1-10V - Dali		Excl. (pag. 15)
		50.000h L70 B10		3
		110°		93
		IP 44		2700K - 3000K - 4000K
		75mm H 14mm		68

HA610 015 902 08	4W	110°	270 lm	930	
HA610 015 903 08	4W	110°	270 lm	940	
HA205 010 211 08				BR	
HA615 000 301 01				MV	





## FLAT FR68-LED SQUARE



	O/F - 1-10V - Dali - CAS	Excl. (zie pag. 15)
	60.000h L70 B10	3
	110°	93
	IP 44	2700K - 3000K - 4000K
	75x75mm H 14mm	68

HA202 031 880 04

4W 110° 312 lm 930

HA205 010 212 08

BR

HA615 000 301 01

MV

## FLAT AQ78-LED SQUARE



	O/F - 1-10V - Dali	Excl. (zie pag. 15)
	60.000h L70 B10	3
	80°	98
	IP 44	3000K - 4000K
	90x90mm H 14mm	78

HA610 015 102 01

7,5W 80° 450 lm 930

HA610 015 102 03

7,5W 80° 450 lm 930

HA610 015 103 01

7,5W 80° 450 lm 940

HA610 015 103 03

7,5W 80° 450 lm 940

### Extra

HA615 000 301 01

MV

HA215 300 610 01

AK 1m

HA215 300 625 01

AK 2m

## LED DRIVER



HA206 040 023 01	5W	6 way
HA206 040 011 01	15W	12 way
HA206 040 012 01	30W	12 way
HA206 040 031 01	60W	12 way
HA206 040 019 01	75W	12 way
HA206 040 033 01	100W	12 way
HA206 040 030 02	200W	12 way

## LED 24V DIMMING



HA208 050 030 01	1-10V C
HA615 000 505 11	Dali C



## TOLVA GU10



				5
		IP 20		
		60mm H 55mm		57

NE00293-0GU



NE00293-1GU



NE00293-8GU



## INOX S GU10



				5
		IP 44		
		80mm H 55mm		72

NE00230-0GU



NE00230-1GU



NE00230-8GU



## INOX S SQUARE ORIENTABLE GU10



				5
		IP 20		
		90X90mm H 55mm		82

NE00291-0GU



NE00291-1GU



NE00291-8GU



## INOX S ROUND ORIENTABLE GU10



				5
		IP 20		
		90mm H 55mm		82

NE00292-0GU



NE00292-1GU



NE00292-8GU



## INOX S SQUARE ORIENTABLE



		O/F - PC - Dali - BT		Incl.
		65.000h L80 B10		5
		20° - 40° - 60°		>90
		IP 44		DTW 1800K/3000K 2700K - 3000K - 4000K
		90x90mm H ~mm		82

NE00291-0E40	65mm	6W	40°	780 lm	930	
NE00291-0E41		9W	40°	1070 lm	930	
NE00291-0E42	83mm	13W	40°	1400 lm	930	

## INOX S ROUND ORIENTABLE



		O/F - PC - Dali - BT		Excl.
		65.000h L80 B10		5
		20° - 40° - 60°		>90
		IP 44		DTW 1800K/3000K 2700K - 3000K - 4000K
		90mm H ~mm		82

NE00292-0E40	65mm	6W	40°	780 lm	930	
NE00292-0E41		9W	40°	1070 lm	930	
NE00292-0E42	83mm	13W	40°	1400 lm	930	
NE00292-0F42R		13W	40°	1400 lm	940	
NE00292-0F42D		13W	40°	1400 lm	940	
NE00292-0F42B		13W	40°	1400 lm	940	

## CONFORT S ADJUSTABLE



		O/F - PC - Dali		Incl.
		65.000h L80 B10		5
		15° - 36° - 50°		>90
		IP 65		2700K - 3000K - 4000K
		100mm H 58mm		75

NE00217-0E30		6W	36°	600 lm	930	
NE00217-1E30		6W	36°	600 lm	930	
NE00217-2E30		6W	36°	600 lm	930	

## TOLVA



		O/F - PC - Dali - BT		Incl.
		65.000h L80 B10		5
		20° - 40° - 60°		>90
		IP 20 / 54		DTW 1800K/3000K 2700K - 3000K - 4000K
		~mm H ~mm		57/85

NE00293-1E40	60mm H 62mm	6W	40°	780 lm	930	
NE00293-1E41		9W	40°	1070 lm	930	
NE00293-1E42	60mm H 80mm	13W	40°	1400 lm	930	
NE00411-1E40	90mm H 93mm	6W	40°	780 lm	930	
NE00411-1E41		9W	40°	1070 lm	930	
NE00411-1E42	90mm H 111mm	13W	40°	1400 lm	930	

## TOLVA L SYMMETRIC



		O/F - PC - Dali - BT		Incl.
		65.000h L80 B10		5
		20° - 40° - 60°		>90
		IP 20 / 54		DTW 1800K/3000K 2700K - 3000K - 4000K
		105mm H ~mm		100

NE00401-DE40	118mm	6W	40°	780 lm	930	
NE00401-DE41		9W	40°	1070 lm	930	
NE00401-DE42	136mm	13W	40°	1400 lm	930	



## TOLVA L ASYMMETRIC



		O/F - PC - Dali - BT		Incl.
		65.000h L80 B20		5
		20° - 40° - 60°		>90
		IP 20 - 54		DTW 1800K/3000K 2700K - 3000K - 4000K
		105mm H ~mm		100

NE00402-DE40	94mm	6W	40°	780 lm	930	
NE00402-DE41		9W	40°	1070 lm	930	
NE00402-DE42	109mm	13W	40°	1400 lm	930	

## HOL



		O/F - PC		Incl.
		35.000h L80 B20		3
		100°		>80
		IP 20 / 54		CCT 2700K/3000K/4000K
		~mm H 52mm		90/120/200

NE01840-1S90	111mm	6W	100°	660 lm	8~	
NE01840-0S90		6W	100°	660 lm	8~	
NE01850-1S91	146mm	9W	100°	1200 lm	8~	
NE01850-0S91		9W	100°	1200 lm	8~	
NE01870-1S93	226mm	21W	100°	2900 lm	8~	
NE01870-0S93		21W	100°	2900 lm	8~	

## HOLP



		O/F -Dali - PC		Incl.
		65.000h L80 B10		5
		100°		>80
		IP 20 / 54		CCT 2700K/3000K/4000K
		~mm H 52mm		

NE01845-0S90	111mm	6W	100°	750 lm	8~	
NE01845-1S90		6W	100°	750 lm	8~	
NE01855-0S91	146mm	9W	100°	1200 lm	8~	
NE01855-1S91		9W	100°	1200 lm	8~	
NE01875-0S93	226mm	21W	100°	2950 lm	8~	
NE01875-1S93		21W	100°	2950 lm	8~	



## ARIZONA DOWNLIGHT



		O/F - Dali - 1-10V		Incl.
		50.000h L70 B50		5
		60°		>80
		IP 54		CCT 3000K/4000K/5700K
		~mm H ~mm		90/135/160/195

TDLA10UCCT0	110x55mm	10W	60°	1470 lm	8~	
TDLA10UCCT2		10W	60°	1470 lm	8~	
TDLA20UCCT0	165x75mm	20W	60°	3140 lm	8~	
TDLA24UCCT0	194x80mm	24W	60°	3936 lm	8~	
TDLA35UCCT0	230x90mm	35W	60°	5635 lm	8~	

### Accessoire

TLADLA10S0	Surface mounting cylinder	10W				
TLADLA10S2	Surface mounting cylinder	10W				
TLADLA20S0	Surface mounting cylinder	20W				
TLADLA24S0	Surface mounting cylinder	24W				

# LIBERTAD



		TRIAC		Incl.
		30.000h		3
		60°		>80
		IP 44		CCT 2700K/3200K/4000K
		~mm H ~mm		68/90/120

HOF111307118	81mm H 79mm	6W	60°	478 / 545 / 537 lm	8~	
HOF111307218		6W	60°	424 / 483 / 470 lm	8~	
HOF111317118	103mm H 91mm	9W	60°	737 / 832 / 820 lm	8~	
HOF111317218		9W	60°	627 / 711 / 695 lm	8~	
HOF111327118	140mm H 102mm	12W	60°	984 / 1140 / 1092 lm	8~	
HOF111327218		12W	60°	840 / 972 / 924 lm	8~	



## BANGKOK



		TRIAC		Incl.
		30.000h		3
		60°		>80
		IP 65		CCT 2700K/3200K/4000K
		88mm H 64mm		70

HOF110667118	6W	60°	490/570/545 lm	8~	
--------------	----	-----	----------------	----	--

### Extra

HOF110668001					
HOF110668002					

## LAOS GEN 2



		O/F - Dali		Excl.
		40.000h L80 B20		3
		24°		>90
		IP 40		2700K - 4000K
		~mm H ~mm		63/75/107

HOF111600112	65mm H 55mm	8W	24°	645 lm	930	
HOF111600114		8W	24°	685 lm	940	
HOF111610112	85mm H 75mm	12W	24°	1050 lm	930	
HOF111610114		12W	24°	1115 lm	940	
HOF111620112	102mm H 95mm	20W	24°	1715 lm	930	
HOF111620114		20W	24°	1820 lm	940	

### Driver

HOF430691101	ON/OFF	5,5 - 22W	125 - 500mA
HOF410396101	DALI	3 - 12W	150 - 400mA
HOF430696101	DALI	3 - 38W	300 - 1050mA
HOF430691102	ON/OFF	15 - 32W	350 - 725mA

## STUTT GART



		TRIAC		Excl.
		50.000h		3
		45°		>80
		IP 44 Front		CCT 2700K/3000K/4000K
		82mm H 30mm		70

HOF110670118	6W	45°	520/590/580 lm	8~	
--------------	----	-----	----------------	----	--

### Accessoire

HOF110678001	Black Frame
--------------	-------------

### Driver

HOF410317101	TRIAC + SB	6W	255mA	220V
--------------	------------	----	-------	------



## LAOS 12 ADJUSTABLE



		O/F - Dali		Excl.
		40.000h L80 B20		3
		25°		>80
		IP 40		3000K - 4000K
		93mm H 66mm		78

HOF111070112	12W	25°	980 lm	830	
HOF111070114	12W	25°	1030 lm	840	
<b>Driver</b>					
HOF430611102	On/Off	3-13W	300mA		
HOF430696101	Dali	3-38W	300-1050mA		

## LAOS 12 DEEP ADJUSTABLE



		O/F - Dali		Excl.
		40.000h L80 B20		3
		25°		>80
		IP 40		3000K - 4000K
		103mm H 78mm		90

HOF111050112	12W	25°	1045 lm	830	
HOF111050114	12W	25°	1100 lm	840	
<b>Driver</b>					
HOF430611102	On/Off	3-13W	300mA		
HOF430696101	Dali	3-38W	300-1050mA		

## DRAC ROUND



	O/F - Dali - BT		Incl.
	65.000h L80 B10		5
	60°		>90
	IP 44		2700K - 3000K - 4000K
	~mm H 92mm		100/150

NE01430-0E62	113mm	12W	60°	1900 lm	930	
NE01430-0E63		18W	60°	2700 lm	930	
NE01430-0E64		25W	60°	3700 lm	930	
NE01420-0E62	165mm	12W	60°	1900 lm	930	
NE01420-0E63		18W	60°	2700 lm	930	
NE01420-0E64		25W	60°	3700 lm	930	
NE01420-0E65		33W	60°	4500 lm	930	
NE01420-0E66		35W	60°	5800 lm	930	
NE01420-0E67		42W	60°	6300 lm	930	

## BOSTON



	O/F - Dali		Excl.
	50.000h		3
	60°		>90
	IP 44		CCT 2700K/3200K/4000K
	~mm H ~mm		90/145/195

HOF111450118	114mm H 66mm	10W	60°	800 / 905 / 870 lm	9~	
HOF111460118	174mm H 87mm	20W	60°	1620 / 1805 / 1730 lm	9~	
HOF111470118	232mm H 110mm	25W	60°	2275 / 2535 / 2520 lm	9~	

### Driver

HOF430611103	On/Off	3 -15W	350mA
HOF430493102	Dali	20W	250-700mA
HOF430696101	Dali	3-38W	300-1050mA
HOF430631101	On/Off	3,5-30W	700mA
HOF430691103	On/Off	13-40W	300-1050mA



## NORWAY ROUND



	O/F - Dali		Excl.
	40.000h L80 B20		3
	100°		>80
	IP 65		CCT 2700K/3200K/4000K
	~mm H ~mm		112/145/165

HOF111100118	120mm H 50mm	9W	100°	935 / 1035 / 1040 lm	8~	<input type="checkbox"/>
HOF111110118	155mm H 52mm	15W	100°	1435 / 1575 / 1580 lm	8~	<input type="checkbox"/>
HOF111120118	175mm H 55mm	20W	100°	1925 / 2135 / 2140 lm	8~	<input type="checkbox"/>

### Driver

HOF430611101	On/Off	2,5-12W	250mA
HOF430611103	On/Off	3-15W	350mA
HOF430691101	On/Off	5,5-22W	125-500mA
HOF410696102	Dali	5,5-22W	125-500mA
HOF430696101	Dali	3-38W	300-1050mA

## ROMANIA



	O/F - Dali		Excl.
	40.000h		3
	60°		>80
	IP 65		3000K - 4000K
	~mm H ~mm		110/150

HOF210010112	130mm H 70mm	20W	60°	1620 lm	830	<input type="checkbox"/>
HOF210020112	165mm H 80mm	30W	60°	2400 lm	830	<input type="checkbox"/>

### Driver

HOF430696101	Dali	3-38W	300-1050mA
HOF430621101	On/Off	2,5-22W	500mA
HOF430631101	On/Off	3,5-30W	700mA

## CIM



		O/F - 1-10V - PC - CAS - Dali		Incl.
		100.000h L80 B20		5
		20° - 30° - 40° - 60°		>90 - 98 - 97
		IP 20		3000K - 4000K - B - M - F - V - R
		150mm H 132mm		140

LUCIM99445W	9,5W	40°	1550 lm	940	
LUCIM199445W	19W	40°	2950 lm	940	
LUCIM269445W	26W	40°	3450 lm	940	
LUCIM319445W	31W	40°	4300 lm	940	

## WRL

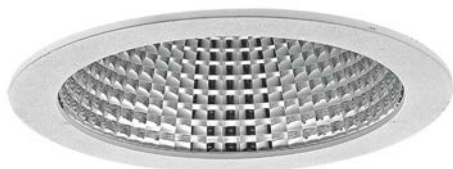

		O/F - 1-10V - PC - CAS - Dali		Incl.
		100.000h L80 B20		5
		50°		>80 - >90 - 98 - 97
		IP 20		3000K - 4000K - B - M - F - V - R
		~mm H ~mm		170/190/210/240

LUWRLS309450W	180mm H 122mm	30W	50°	3350 lm	940	
LUWRLS389450W		38,5W	50°	4550 lm	940	
LUWRLM309450W	200mm H 120mm	30W	50°	3400 lm	940	
LUWRLM389450W		38,5W	50°	4650 lm	940	
LUWRLL309450W	225mm H 129mm	30W	50°	3400 lm	940	
LUWRLL389450W		38,5W	50°	4650 lm	940	
LUWRLXL309450W	260mm H 160mm	30W	50°	3400 lm	940	
LUWRLXL389450W		38,5W	50°	4650 lm	940	





## TOPO

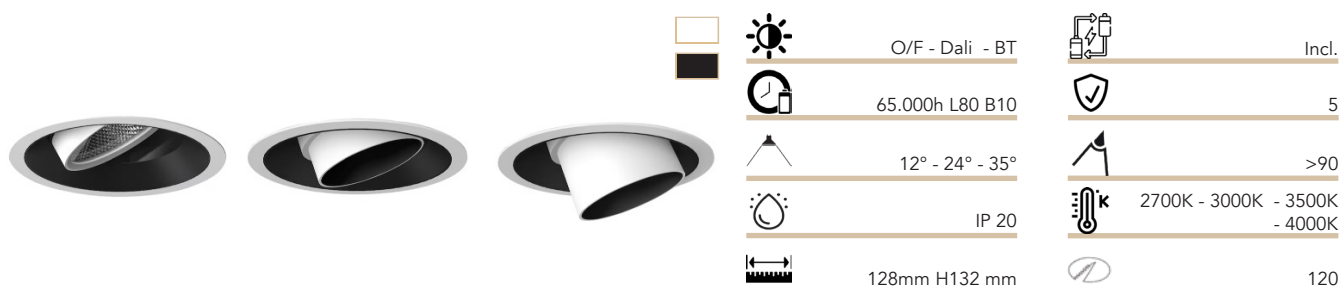

NE03611-111E22	12W	24°	1900 lm	930	
NE03611-111E23	18W	24°	2600 lm	930	
NE03611-111E24	25W	24°	3600 lm	930	
NE03611-111E25	33W	24°	4400 lm	930	

## DON X-FLIP

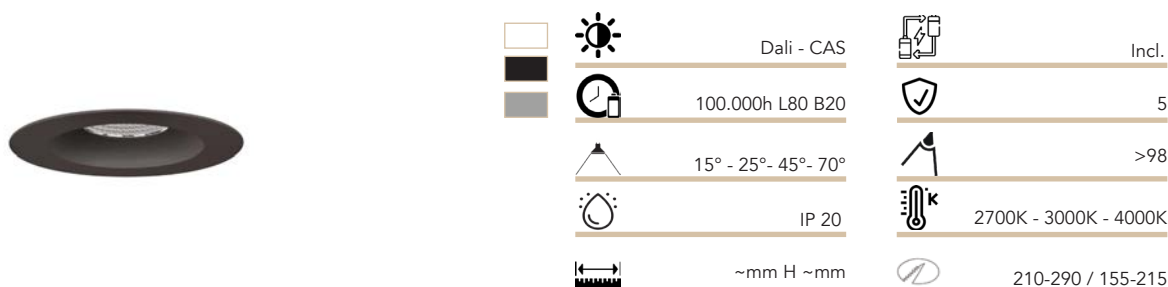

LUDONM99345W	225x120mm	9,5W	45°	1400 lm	930	
LUDONM149345W		14W	45°	2000 lm	930	
LUDONM199345W		19W	45°	2600 lm	930	
LUDONL99345W	300x120mm	9,5W	45°	1300 lm	930	
LUDONL149345W		14W	45°	1900 lm	930	
LUDONL199345W		19W	45°	2500 lm	930	

## PRO N



A



B

		O/F - Dali - BT		Incl.
		65.000h		5
		60° - 80°		>80 - >90
		IP 43 / 54		2700K - 3000K - 4000K
		~mm H ~mm		155/212

Model	Type	Dimensions	Power	Beam	Light	Temp	Color
NE01135-1E62	A	170mm H 60mm	12W	60°	1900 lm	930	Black
NE01135-1E63			18W	60°	2600 lm	930	Black
NE01135-1E64			25W	60°	3600 lm	930	Black
NE01145-1E82			12W	80°	1900 lm	930	Black
NE01145-1E83			18W	80°	2600 lm	930	Black
NE01145-1E84			25W	80°	3600 lm	930	Black
NE01136-1E62	B	230mm H 75mm	12W	60°	1900 lm	930	Black
NE01136-1E63			18W	60°	2600 lm	930	Black
NE01136-1E64			25W	60°	3600 lm	930	Black
NE01136-1E65			33W	60°	4400 lm	930	Black
NE01146-1E82			12W	80°	1900 lm	930	Black
NE01146-1E83			18W	80°	2600 lm	930	Black
NE01146-1E84			25W	80°	3600 lm	930	Black
NE01146-1E85			33W	80°	4400 lm	930	Black

## PULL OUT MINI



		O/F - Dali - BT		Incl.
		65.000h L80 B20		5
		10° - 40°		>90
		IP 20		2700K - 3000K - 4000K
		137mm H 125mm		127

NE03340-0E32			12,5W	40°	1400 lm	930	White
NE03340-0E33			18W	40°	1800 lm	930	White

## LED MULTI



		TRIAC		Incl.
		50.000h L80 B10		5
		36°		>80
		IP 20		3000K - 4000K
		~mm H ~mm		85/165/200

IGMUS10840W		96mm H 74mm	10W	36°	1100 lm	840	White
IGMUM2040840W		180mm H 147mm	20-40W	36°	2400-4800 lm	840	White
IGMUL2040840W		235mm H 144mm	20-40W	36°	2400-4800 lm	840	White

## FUL



		Dali - CAS - 1-10V		Incl.
		100.000h L80 B20		5
		15° - 24° - 25° - 36° - 45° - 60°		>98
		IP 20		CCT 2700K / 5700K - TW - V - B - M - F - R
		~mm H ~mm		140/185

LUFULS993045W	150x111mm	9,5W	45°	1450lm	930	<input type="checkbox"/>
LUFULS193045W		19W	45°	2750lm	930	<input type="checkbox"/>
LUFULS2393045W		23W	45°	3350lm	930	<input type="checkbox"/>
LUFULL93045W	195x135mm	9,5W	45°	1050lm	930	<input type="checkbox"/>
LUFULL183045W		18W	45°	2000lm	930	<input type="checkbox"/>
LUFULL3093045W		30W	45°	3000lm	930	<input type="checkbox"/>
LUFULL3893045W		38,5W	45°	4100lm	930	<input type="checkbox"/>

## SAN



		Dali - CAS		Incl.
		100.000h L80 B20		5
		15° - 20° - 24° - 25° - 30° - 36° - 40° - 45° - 60° - 65°		>98
		IP 20		2700K - 3000K - 3500K - 4000K
		~mm H ~mm		125/155/185

LUSANS99345W	133x92mm	9,5W	45°	1350lm	930	<input type="checkbox"/>
LUSANS19345W		19W	45°	2650lm	930	<input type="checkbox"/>
LUSANM993045W	165x125mm	9,5w	45°	1450lm	930	<input type="checkbox"/>
LUSANM199345W		19W	45°	2750lm	930	<input type="checkbox"/>
LUSANM239345W		23W	45°	3350lm	930	<input type="checkbox"/>
LUSANM319345W		31W	45°	4150lm	930	<input type="checkbox"/>
LUSANM409345W		40W	45°	5450lm	930	<input type="checkbox"/>
LUSANL993045W	195x144mm	9,5W	45°	1400lm	930	<input type="checkbox"/>
LUSANL199345W		19W	45°	2600lm	930	<input type="checkbox"/>
LUSANL319345W		31W	45°	3850lm	930	<input type="checkbox"/>
LUSANL469345W		46,5W	45°	5650lm	930	<input type="checkbox"/>



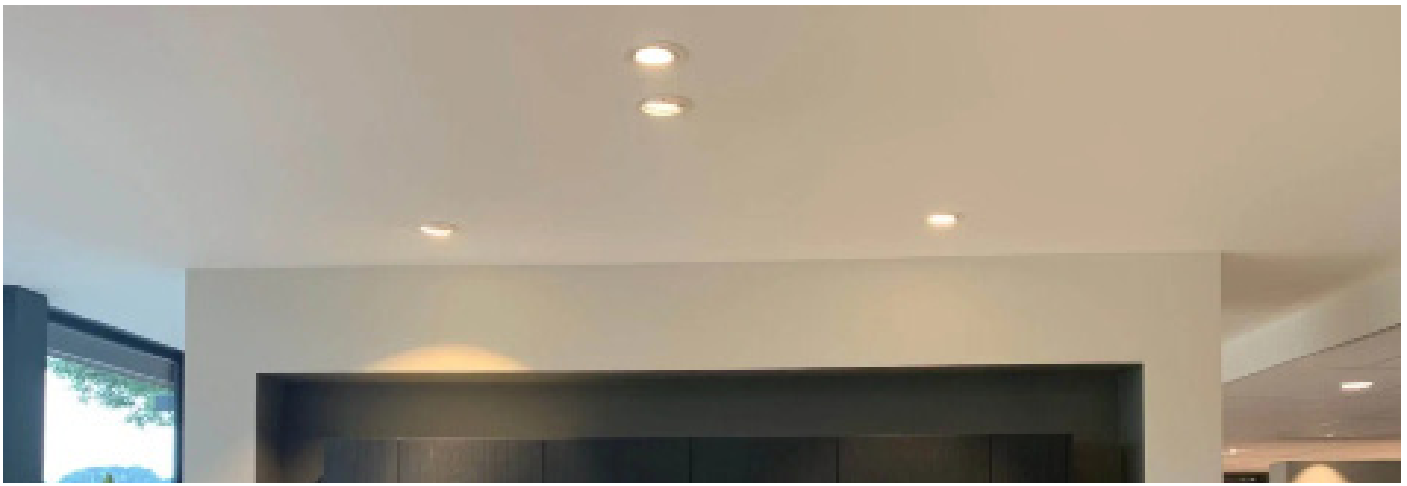

## PULL OUT



		O/F - Dali - BT		Incl.
		65.000h L80 B10		5
		10° - 20° - 40° - 70°		>80 - >90 - 97
		IP 20		2700K - 3000K - 4000K - B - M - F - V - R
		188mm H 160mm		175

NE03330-0E32	12W	40°	1900 lm	930	
NE03330-0E33	18W	40°	2600 lm	930	
NE03330-0E34	25W	40°	3500 lm	930	
NE03330-0E35	33W	40°	4300 lm	930	
NE03330-0E36	35W	40°	5800 lm	930	
NE03330-0R33	18W	40°	2000 lm	97R	
NE03330-0M33	18W	40°	2000 lm	80M	
NE03330-0P33	18W	40°	2000 lm	80F	
NE03330-0B33	25W	40°	2000 lm	80B	
NE03330-0V33	25W	40°	2000 lm	80V	

## PAW



		O/F - Dali - BT		Incl.
		50.000h L70 B30		5
		15° - 24° - 36° - 50°		>90
		IP 20		2700K - 3000K - 4000K
		80mm H 92mm		67

NE06812-1E30	6W	36°	600 lm	930	
NE06812-1F30	6W	36°	600 lm	940	
NE06812-0E30	6W	36°	600 lm	930	
NE06812-0F30	6W	36°	600 lm	940	
NE06812-1E31	9W	36°	900 lm	930	
NE06812-1F31	9W	36°	900 lm	940	
NE06812-0E31	9W	36°	900 lm	930	
NE06812-0F31	9W	36°	900 lm	940	



## ANDORRA ADJUSTABLE



O/F - Dali



Excl.



40.000h



3



24°



>90



IP 20



3000K



~mm H ~mm



90/120/145

HOF110700112	100mm H 110mm	12W	24°	780 lm	930	
HOF110700212		12W	24°	780 lm	930	
HOF110710112	130mm H 125mm	20W	24°	1300 lm	930	
HOF110710212		20W	24°	1300 lm	930	
HOF110720112	160mm H 150mm	30W	24°	1950 lm	930	
HOF110720212		30W	24°	1950 lm	930	

### Driver

HOF43061102	On/Off	3-13W	300mA
HOF430696101	Dali	3-38W	300-1050mA
HOF430621101	On/Off	2,5-22W	500mA
HOF430631101	On/Off	3,5-30W	700mA

## DRAC SQUARE



O/F - Dali - BT



Incl.



65.000 L80 B10



5



60° - 80°



>90



IP 33



2700K - 3000K - 3500K - 4000K



~mm H ~mm



100x100/175x175

NE01630-0E62	115x115mm H 92mm	12W	60°	1500 lm	930	
NE01630-0E63		17,5W	60°	2000 lm	930	
NE01630-0E64		25W	60°	3000 lm	930	
NE01620-0E82	190x190mm H 110mm	12W	80°	1950 lm	930	
NE01620-0E83		18W	80°	2700 lm	930	
NE01620-0E84		25W	80°	3700 lm	930	
NE01620-0E85		33W	80°	4500 lm	930	
NE01620-0E86		35W	80°	5800 lm	930	
NE01620-0E87		42W	80°	6300 lm	930	

## NORWAY SQUARE



O/F - Dali



Excl.



40.000h L80 B20



3



100°



>80



IP 65



CCT 2700K/3200K/4000K



~mm H ~mm



105x105 - 135x135 - 160x160

HOF111150118	110x110mm H 50mm	9W	100°	905/ 1005/ 1010 lm	8~	
HOF111160118	145x145mm H 55mm	15W	100°	1335/ 1490/ 1495 lm	8~	
HOF111170118	170x170mm H 55mm	20W	100°	1940/ 2165/ 2170 lm	8~	

### Driver

HOF430611101	On/Off	2,5-12W	250mA
HOF430611103	On/Off	3-15W	350mA
HOF430691101	On/Off	5,5-22W	125-500mA
HOF410966102	Dali	8-42W	150-1050mA
HOF430696101	Dali	3-38W	300-1050mA



## KARDAN M



		O/F - Dali - BT		Incl.
		65.000h L80 B10		5
		10° - 40°		>90
		IP 20		2700K - 3000K - 4000K
		140mm H 80mm		130

NE02375-1E40

19W

40°

1800 lm

930



## KARDAN M SPECIAL



A



B

		O/F - Dali - BT		Incl.
		65.000h L80 B10		5
		15° - 36° - 70°		>90
		IP 20		2700K - 3000K - 4000K - B - M - F - V - R
		140mm H 80mm		130

NE02376-1E32

12W

36°

1900 lm

930



NE02376-1E33

18W

36°

2600 lm

930



NE02376-1E34

25W

36°

3600 lm

930



NE02376-1E35

33W

36°

4400 lm

930



NE02376-1E36

35W

36°

5800 lm

930



### Frame

NE02391-2

A

189x189mm H 185mm



NE02381-2

B

185x185mm H 191mm



## PRO SQ



		O/F - Dali - BT		Incl.
		65.000h L80 B10		5
		80°		>80
		IP 44		3000K - 4000K
		200x200mm H 70mm		180x180mm

NE01681-0C83

21W

80°

2500 lm

830



NE01681-1N83

21W

80°

2500 lm

840



NE01681-2C83

21W

80°

2500 lm

830



## BUD



	O/F - 1-10V - Dali		Incl.
	50.000h L80 B10		5
	60°		>80
	IP 21 / IP 43		3000K - 4000K
	~mm H 96mm		155x155 - 210x210 - 240x240

STBUDS138083W	170x170mm	12W	60°	1380 lm	830	
STBUDS178083W		16W	60°	1780 lm	830	
STBUDM250083W	225x225mm	20W	60°	2500 lm	830	
STBUDM293083W		24W	60°	2930 lm	830	
STBUDL300083W	255x255mm	25W	60°	3000 lm	830	
STBUDL330083W		29W	60°	3300 lm	830	

## PULL OUT SQUARE



	O/F - Dali - BT		Incl.
	50.000h L80 B20		5
	65°		>80 - >90 - 97
	IP 20		2700K - 3000K - 4000K - B - M - F - V - R
	195x125mm H 109mm		185x115

NE03350-0E63		18W	65°	2600 lm	930	
NE03350-0E64		25W	65°	3500 lm	930	
NE03350-0E65		33W	65°	4300 lm	930	
NE03350-0E66		35W	65°	5800 lm	930	
NE03350-0R63		18W	65°	2000 lm	97R	
NE03350-0R64		25W	65°	3000 lm	97R	
NE03350-0M63		18W	65°	2000 lm	80M	
NE03350-0M64		25W	65°	3000 lm	80M	
NE03350-0P63		18W	65°	2000 lm	80F	
NE03350-0P64		25W	65°	3000 lm	80F	
NE03350-0B63		18W	65°	2000 lm	80B	
NE03350-0B64		25W	65°	3000 lm	80B	
NE03350-0V63		18W	65°	2000 lm	80V	
NE03350-0V64		25W	65°	3000 lm	80V	

### Frame

NE03359-0	230x155mm	
NE03359-2	230x155mm	
NE03359-1	230x155mm	

## NAN BI



		O/F - 1-10V - PC - CAS - Dali		Incl.
		100.000h L80 B20		5
		90x60° - 90x70°		>90 - 98 - 97
		IP 20		3000K - 4000K - B - M - F - V - R
		~mm H ~mm		165x120 - 210x140

LUNANBIS993W	175x133mm H 88mm	9,5W	90x60°	1100 lm	930	
LUNANBIS1993W		18,5W	90x60°	2100 lm	930	
LUNANBIS3093W		30W	90x60°	3150 lm	930	
LUNANBIL993W	222x157mm H 100mm	9,5W	90x70°	1100 lm	930	
LUNANBIL1993W		18,5W	90x70°	2100 lm	930	
LUNANBIL2093W		30W	90x70°	3150 lm	930	
LUNANBIL3893W		38W	90x70°	4350 lm	930	

## OREGON+



		O/F		Incl.
		30.000h L70 B50		3
		100°		>90
		IP 20		CCT 3000K/4000K/5700K
		240x145mm H 96mm		215 x 125mm

TLDLO40CC9CCT		38W	100°	3293 / 3816 / 3816 lm	9~	
TLDLO60CC9CCT		60W	100°	5631 / 6500 / 6500 lm	9~	

## BOXET FIX



		O/F - Dali - BT		Incl.
		65.000h L80 B10		5
		12° - 34° - 48°		>90
		IP 20		2700K - 3000K - 4000K
		~mm H 50mm		38/67/141/275x38

NE19101-0E30	45x45mm	2W	34°	210 lm	930	
NE19102-0E30	45x73mm	4W	34°	420 lm	930	
NE19105-0E31	45x148mm	10W	34°	1050 lm	930	
NE19110-0E32	45x282mm	20W	34°	2100 lm	930	

## BOXET ADJUSTABLE



O/F - Dali - BT



Incl.



65.000h L70 B30



5



12° - 34° - 48°



>90



IP 20



3000K - 4000K



68x~mm H 50mm



154/285x55

NE19205-0E31

161mm

10W

34°

1050 lm

930



NE19210-0E30

294mm

20W

34°

2100 lm

930



## KARDAN L



0/F - Dali - BT



Incl.



50.000h



5



10° - 40°



>90



IP 20



2700K - 3000K - 4000K



190x~mm H 122mm



165x165/327/472

NE02431-0E40

190mm

19W

40°

1800 lm

930



NE02432-0E40

355mm

2x19W

40°

2x1800 lm

930



NE02433-0E40

503mm

3x19W

40°

3x1800 lm

930



















	O/F - 1-10V - PC - Dali	Incl.
	50.000h L90 B50	5
	15° - 20° - 30° - 36° - 40° - 45° - 60° - 65°	>90 - 98 - 97
	IP 20	3000K - 4000K - B - M - F - V - R
	~mm H ~mm	

LUCARXS199345W	100x100mm H 88mm / 90x90mm	9,5W	45°	1300 lm	930	
LUCARXS1149345W		14W	45°	1750 lm	930	
LUCARXS1199345W		19W	45°	2450 lm	930	
LUCARXS1239345W		23W	45°	2900 lm	930	
LUCARXS299345W	180x100mm H 88mm / 170x90mm	2x9,5W	45°	2x1300 lm	930	
LUCARXS2149345W		2x14W	45°	2x1750 lm	930	
LUCARXS2199345W		2x19W	45°	2x2450 lm	930	
LUCARXS2239345W		2x23W	45°	2x2900 lm	930	
LUCARXS399345W	260x100mm H 88mm / 250x90mm	3x9,5W	45°	3x1300 lm	930	
LUCARXS3149345W		3x14W	45°	3x1750 lm	930	
LUCARXS3199345W		3x19W	45°	3x2450 lm	930	
LUCARXS3239345W		3x23W	45°	3x2900 lm	930	
LUCARS199345W	168x168mm H 117mm / 155x155mm	9,5W	45°	1450 lm	930	
LUCARS1199345W		19W	45°	2750 lm	930	
LUCARS1239345W		23W	45°	3350 lm	930	
LUCARS1319345W		31W	45°	4150 lm	930	
LUCARS1409345W		40W	45°	5450 lm	930	
LUCARS299345W	322x168mm H117mm / 310x155mm	2x9,5W	45°	2x1450 lm	930	
LUCARS2149345W		2x14W	45°	2x2750 lm	930	
LUCARS2199345W		2x19W	45°	2x3350 lm	930	
LUCARS2239345W		2x23W	45°	2x4150 lm	930	
LUCARS2409345W		2x40W	45°	2x5450 lm	930	
LUCARS399345W	464x168mm H 117 / 452x155mm	3x9,5W	45°	3x1300 lm	930	
LUCARS3199345W		3x19W	45°	3x2750 lm	930	
LUCARS3239345W		3x23W	45°	3x3350 lm	930	
LUCARS3319345W		3x31W	45°	3x4150 lm	930	
LUCARS3409345W		3x40W	45°	3x5450 lm	930	
LUCARL199345W	205x205mm H 157mm / 190x190mm	9,5W	45°	1050 lm	930	
LUCARL1189345W		18,5W	45°	2000 lm	930	
LUCARL1309345W		30W	45°	3000 lm	930	
LUCARL1389345W		38,5W	45°	4100 lm	930	
LUCARL299345W	380x205mm H 158mm / 365x190mm	2x9,5W	45°	2x1050 lm	930	
LUCARL2189345W		2x18,5W	45°	2x2000 lm	930	
LUCARL2309345W		2x30W	45°	2x3000 lm	930	
LUCARL2389345W		2x38,5W	45°	2x4100 lm	930	



## INFINITY IN CEILING



		O/F - Dali		Incl.
		65.000h L80 B10		5
		70°		>90
		IP 43		2700K - 3000K - 4000K - TW
		50x~mm H 80mm		

Model	Length	Power	Beam Angle	Lumen	Height	Color
NE16202-1EL	580mm	12W	70°	1800 lm	930	
NE16202-1EH		22W	70°	3300 lm	930	
NE16203-1EL	860mm	18W	70°	2700 lm	930	
NE16203-1EH		33W	70°	4950 lm	930	
NE16204-1EL	1140mm	24W	70°	3600 lm	930	
NE16204-1EH		44W	70°	6600 lm	930	
NE16205-1EL	1420mm	30W	70°	4500 lm	930	
NE16205-1EH		55W	70°	8250 lm	930	
NE16206-1EL	1700mm	36W	70°	5400 lm	930	
NE16206-1EH		66W	70°	9900 lm	930	
NE16207-1EL	1980mm	42W	70°	6300 lm	930	
NE16207-1EH		77W	70°	11550 lm	930	

## GRILL



	O/F - Dali - BT		Incl.
	50.000h L80 B20		5
	90°		>80
	IP 20		3000K - 4000K
	596x596mm H 30mm		

NE14201-OC95	36W	90°	3600 lm	830	<input type="checkbox"/>
NE14201-OC96	46W	90°	4500 lm	830	<input type="checkbox"/>

## EZ



	O/F - Dali		Incl.
	50.000h L80 B20		5
	60°		>80
	IP 20		CCT 3000K/4000K/5000K
	~mm H ~mm		

AGEZMULTIPANEL6060	595x595mm	21-40W	140 lm/W	8~	<input type="checkbox"/>
AGEZMULTIPANEL6060DA		21-40W	140 lm/W	8~	<input type="checkbox"/>
AGEZMULTIPANEL30120	1195x295mm	21-40W	140 lm/W	8~	<input type="checkbox"/>
AGEZMULTIPANEL30120DA		21-40W	140 lm/W	8~	<input type="checkbox"/>

## CANADA GEN 2

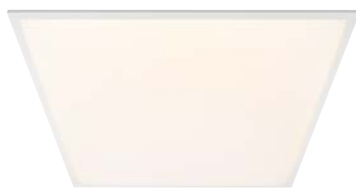

	O/F - 0-10V - Dali		Excl.
	40.000h		4
	110°		>80
	IP 20		CCT 3000K/3500K/4000K
	595x595mm H 28mm		

HOF160040118		40W	110°	3830 / 4160 / 3970 lm	8~	<input type="checkbox"/>
<b>Driver</b>						<input type="checkbox"/>
HOF410356102	ON/OFF	33-40W	1000mA			<input type="checkbox"/>
HOF410356101	DALI - 0-10V- Push	40W	350-1050mA			<input type="checkbox"/>
HOF492310101	NOOD 1h	9-58V				<input type="checkbox"/>
<b>Extra</b>						<input type="checkbox"/>
HOF160048101	Mounting frame	600x600x70mm				<input type="checkbox"/>
HOF160048001	Clips 4 U					<input type="checkbox"/>
HOF160048002	OST 4 U	1,5m				<input type="checkbox"/>

## MICROPOLIS



	1-10V - Dali - CAS		Incl.
	50.000h L80 B20		5
	120°		>90
	IP 20 / IP 40		4000K
	~mm H ~mm		

TLP3030BN	295x295x10,7mm	12W	110°	960 lm	840	<input type="checkbox"/>
TLP3060BN	595x295x9,6mm	18W	110°	1620 lm	840	<input type="checkbox"/>

## TRIPOLIS



	0-10V - Dali - Push - CAS - O/F		Incl.
	50.000h		5
	120°		>80
	IP 20 / IP 40		3000K - 4000K - 6000K
	~mm H ~mm		

TLP6060UGRBC	595x595x10mm	40W	120°	3800 lm	830	<input type="checkbox"/>
TLP30120UGRBC	1195x295x10mm	40W	120°	3800 lm	830	<input type="checkbox"/>
TLP60120UGRBC	1195x595x11mm	50W	120°	4750 lm	830	<input type="checkbox"/>

## ACCESSOIRES MICROPOLIS & TRIPOLIS



TLASM60X60V3	OF 60x60x70mm
TLASM30X120V3	OF 30x120x70mm
TLASM60X120V3	OF 60x120x70mm
TLAEM30X120	IF 30x120mm
TLAEM60X120	IF 60x120mm
TLAEM30X60	IF 30x60
TLASM3030	OF micropolis 30x30x45mm
TLAEM3030	IF micropolis 30x30mm
TLAEM3060	IF micropolis 30x60mm
TLASP60X60	Clips 4 U inbouw 60x60mm
TLSL20	SL
TLSP20	BS
TLKEU603	NOOD
T LCS2G	SD

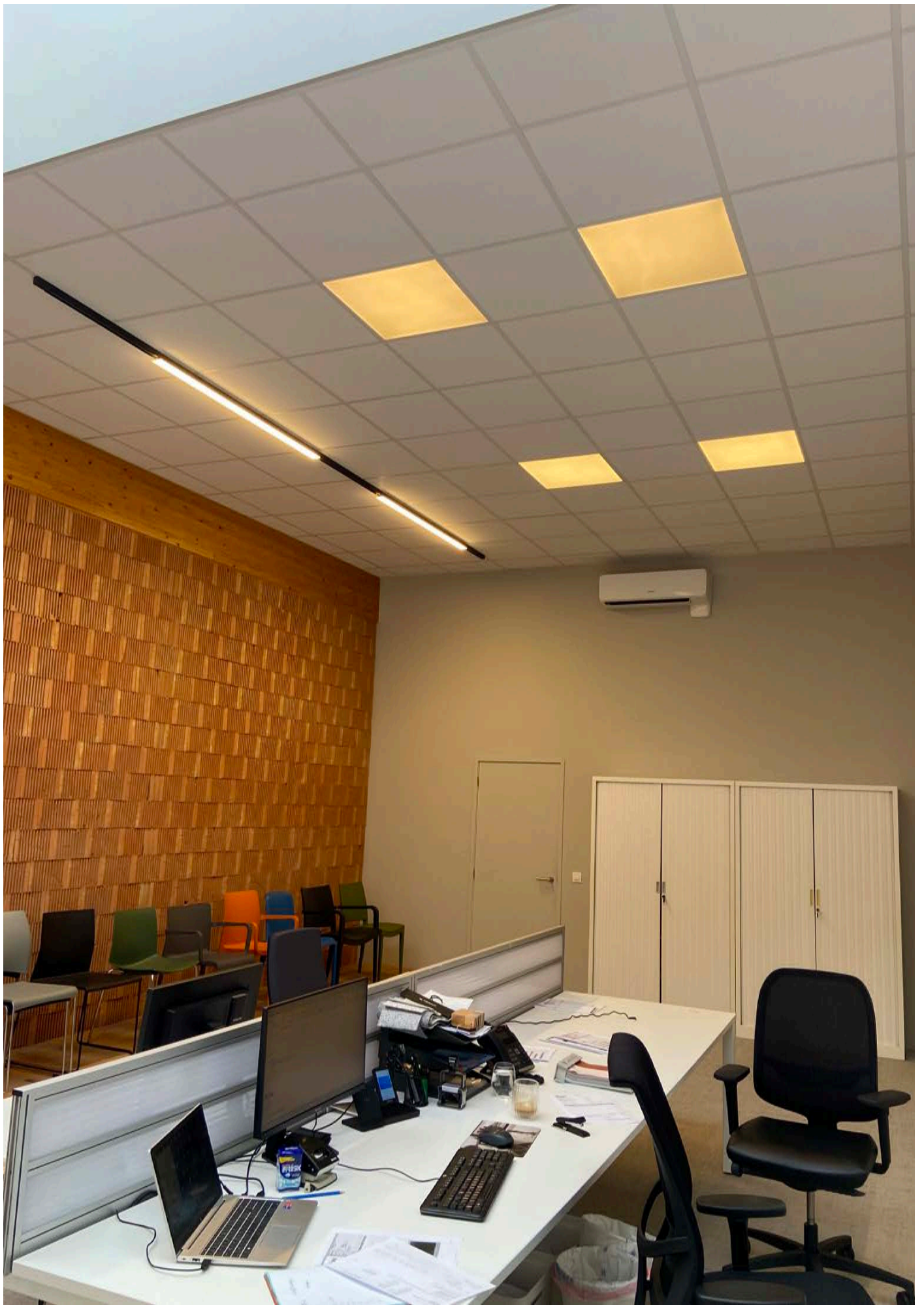

# EK

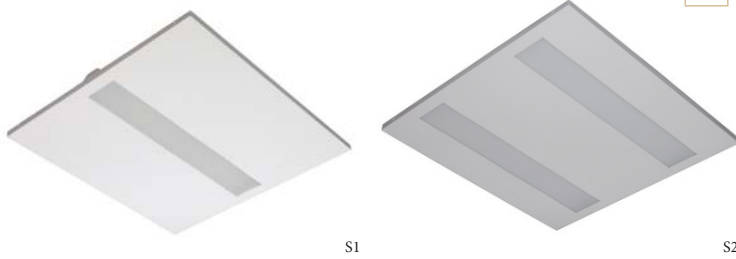

	O/F - 1-10V - Dali - BT		Incl.
	80.000h L80 B50		5
	90°		>80 - >90
	IP 40		2700K - 3000K - 4000K - 5700K
	595x595mm H 35 mm		

MOEK1950S184	S1	15W	90°	1950 lm	840	
MOEK2650S184	S1	20W	90°	2650 lm	840	
MOEK2800S284	S2	19W	90°	2800 lm	840	
MOEK4100S284	S2	30W	90°	4100 lm	840	
MOEK6000S284	S2	48W	90°	6000 lm	840	
MOEK6100S384	S3	44W	90°	6100 lm	840	

# EK RECTANGLE



	O/F - 1-10V - Dali - BT		Incl.
	80.000h L80 B50		5
	90°		>80 - >90
	IP 40		2700K - 3000K - 4000K - 5700K
	1196x296mm H 35 mm		

MOEK4200R184		28W	90°	4200 lm	840	
MOEK5900R184		51W	90°	5900 lm	840	

# ID

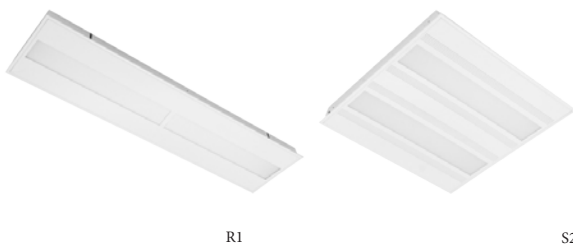

	O/F - 1-10V - Dali - BT		Incl.
	80.000h L80 B50		5
	90°		>80
	IP 20		2700K - 3000K - 4000K - 5700K - 6500K
	~mm H 64 mm		576x576/1176x276

MOID4100S284	S2	596x596mm	33W	90°	4100 lm	840	
MOID5800S284			50W	90°	5800 lm	840	
MOID4100R184	R1	1196x296mm	33W	90°	4100 lm	840	
MOID5800R184			50W	90°	5800 lm	840	

## IS

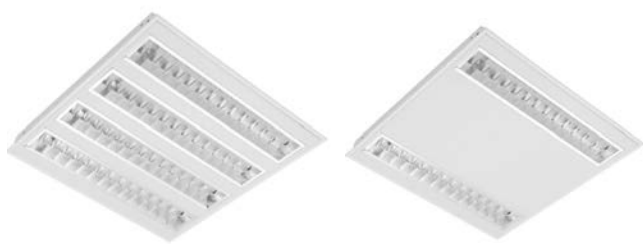

S4

S2

	O/F - 1-10V - Dali - BT		Incl.
	80.000h L80 B50		5
	60°		>80 - >90
	IP 20		2700K - 3000K - 4000K - 5700K - 6500K
	596x596mm H 52 mm		576x576

MOIS3600S284	S2	33W	60°	3600 lm	840	
MOIS3500S484	S4	27W	60°	3500 lm	840	
MOIS4700S484	S4	37W	60°	4700 lm	840	

## IS RECTANGLE



R2

	O/F - 1-10V - Dali - BT		Incl.
	80.000h L80 B50		5
	60°		>80 - >90
	IP 20		2700K - 3000K - 4000K - 5700K - 6500K
	1196x296mm H 52 mm		1176x276

MOIS3500R284		27W	60°	3500 lm	840	
MOIS4700R284		37W	60°	4700 lm	840	

## EB

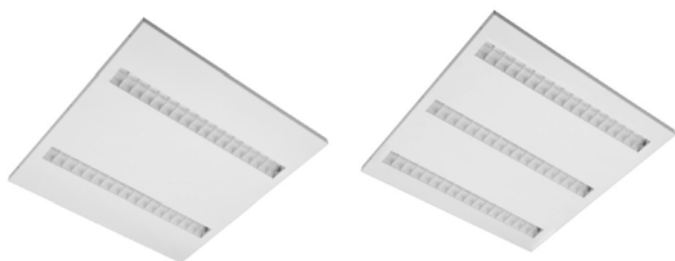

	O/F - 1-10V - Dali - BT		Incl.
	80.000h L80 B50		5
	90°		>80
	IP 20		2700K - 3000K - 4000K - 5700K - 6500K
	596x596mm H 23 mm		

MOEB2800S84		19W	90°	2800 lm	840	
MOEB3800S84		26W	90°	3800 lm	840	
MOEB5500S84		42W	90°	5500 lm	840	

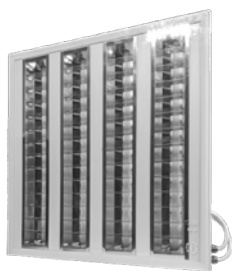

		O/F - Dali		Incl.
		80.000h L80 B50		5
		60°		>80 - >90
		IP 65		2700K - 3000K - 4000K - 5700K - 6500K
		~mm H 57 mm		

MOCR5000S84	596x596mm	43W	60°	5000 lm	840	
MOCR5000R84	1196x296mm	43W	60°	5000 lm	840	
MOCR11000R84	1196x596mm	100W	60°	11000 lm	840	



# ES



		O/F - 1-10V - Dali - BT		Incl.
		80.000h L80 B50		5
		50° - 80°		>80 - >90
		IP 20		2700K - 3000K - 4000K - 5700K - 6500K
		596x596mm H 25 mm		

MOES1400S184	S1	11W	80°	1400 lm	840	
MOES3000S184	S1	22W	80°	3000 lm	840	
MOES2900S284	S2	23W	80°	2900 lm	840	
MOES4400S284	S2	28W	80°	4400 lm	840	
MOES6100S284	S2	42W	80°	6100 lm	840	
MOES2750S484	S4	18W	80°	2750 lm	840	
MOES3900S484	S4	27W	80°	3900 lm	840	

# ES RECTANGLE



		O/F - 1-10V - Dali - BT		Incl.
		80.000h L80 B50		5
		50° - 80°		>80 - >90
		IP 20		2700K - 3000K - 4000K - 5700K - 6500K
		1196x296mm H 25 mm		

MOES2900R184		23W	80°	2900 lm	840	
MOES4400R184		28W	80°	4400 lm	840	
MOES6100R184		42W	80°	6100 lm	840	



## ED

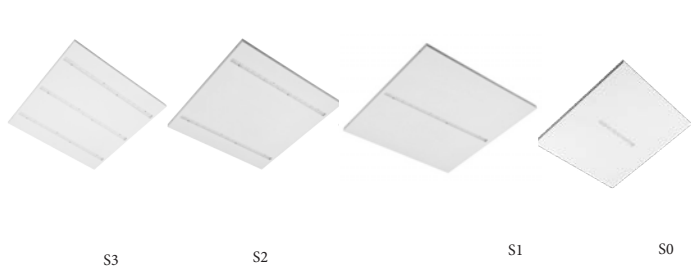

	O/F - 1-10V - Dali - BT		Incl.
	80.000h L80 B50		5
	60° - 90° - AS		>80
	IP 20		2700K - 3000K - 4000K - 5700K - 6500K
	~mm H 15 mm		

MOED1000S0584	S0	596x596mm	7W	60°	1000 lm	840	<input type="checkbox"/>
MOED1300S0584	S0		10W	60°	1300 lm	840	<input type="checkbox"/>
MOED1300S184	S1		10W	60°	1300 lm	840	<input type="checkbox"/>
MOED2000S184	S1		14W	60°	2000 lm	840	<input type="checkbox"/>
MOED2700S184	S1		19W	60°	2700 lm	840	<input type="checkbox"/>
MOED2700S284	S2		18W	60°	2700 lm	840	<input type="checkbox"/>
MOED3800S284	S2		26W	60°	3800 lm	840	<input type="checkbox"/>
MOED4000S384	S3		25W	60°	4000 lm	840	<input type="checkbox"/>
MOED5800S384	S3		38W	60°	5800 lm	840	<input type="checkbox"/>
MOED3800R184	R1	1196x296mm	26W	60°	3800 lm	840	<input type="checkbox"/>

## ED RECTANGLE



	O/F - 1-10V - Dali - BT		Incl.
	80.000h L80 B50		5
	60° - 90° - AS		>80
	IP 20		2700K - 3000K - 4000K - 5700K - 6500K
	1196x296mm H 15 mm		

MOED3800R184			26W	60°	3800 lm	840	<input type="checkbox"/>
--------------	--	--	-----	-----	---------	-----	--------------------------

## QN

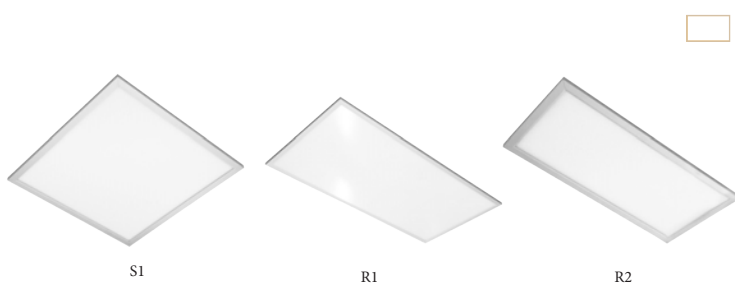

	O/F - 1-10V - Dali - BT		Incl.
	80.000h L80 B50		5
	80°		>80 - >90
	IP 20 / IP 40 40		2700K - 3000K - 3800K - 5300K - 6200K
	~mm H ~mm		

MOQN2000R93	R	596x296mm H 60mm	19W	80°	2000 lm	938	<input type="checkbox"/>
MOQN2800R93	R		26W	80°	2800 lm	938	<input type="checkbox"/>
MOQN2400S93	S1	296x296mm H 15mm	23W	80°	2400 lm	938	<input type="checkbox"/>
MOQN9000R93	R2	1196x296mm H 15mm	68W	80°	9000 lm	938	<input type="checkbox"/>
MOQN12800R93	R1		98W	80°	12 800 lm	938	<input type="checkbox"/>
MOQN5700R93	R3	1496x296mm H 15mm	47W	80°	5700 lm	938	<input type="checkbox"/>
MOQN7400R93	R3		61W	80°	7400 lm	938	<input type="checkbox"/>



## FIT IP65



	O/F - Dali - BT		Incl.
	80.000h L80 B50		5
	80°		>80 - >90
	IP 65		2700K - 3000K - 4000K - 5700K
	~mm H 80mm		

MOFIT653000R84	596x296mm	30W	80°	3000 lm	840	<input type="checkbox"/>
MOFIT656300S84	596x596mm	57W	80°	6300 lm	840	<input type="checkbox"/>
MOFIT655400S94		57W	80°	5400 lm	940	<input type="checkbox"/>
MOFIT656100R84	1196x296mm	57W	80°	6100 lm	840	<input type="checkbox"/>

## INL



	O/F - Dali		Incl.
	80.000h L80 B50		5
	120°		>80
	IP 20		2700K - 3000K - 4000K - 5700K - 6500K
	596x596mm H 97mm		576x576

MOINL2750S84		33W	120°	2750 lm	840	<input type="checkbox"/>
MOINL3800S84		50W	120°	3800 lm	840	<input type="checkbox"/>

## FRAME LEDPANELS

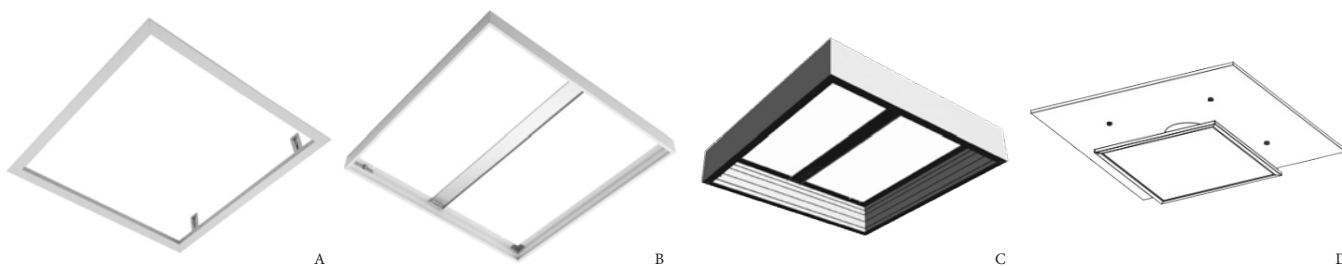

MOFRAME6262MOREC	635x635mm H 85,5mm	A	620x620mm
MOFRAME6232MOREC	635x335mm H 85,5mm	A	620x320mm
MOFRAME12332MOREC	1235x335mm H 85,5mm	A	1220x320mm
MOFRAME12362MOREC	1235x635mm H 85,5mm	A	1220x620mm
MOFRAME3232MOREC	335x335mm H 85,5mm	A	320x320mm
MOFRAME6060MOSUR	603x603mm H 48mm	B	
MOFRAME3060MOSUR	303x603mm H 48mm	B	
MOFRAME30120MOSUR	303x1201mm H 48mm	B	
MOFRAME60120MOSUR	603x1201mm H 48mm	B	
MOFRAME3030MOSUR	303x303mm H 48mm	B	
MOFRAME6363MOSUR	630x630mm H 110mm	C	
MOFRAME12333MOSUR	1230x330mm H 110mm	C	
MOFRAME12363MOSUR	1230x630mm H 110mm	C	
MOFRAMEMAGMOREC		D	MH





OPBOUW  
APPARENT



## WED REC



	O/F - Dali - CAS - 1-10V	Incl.
	100.000h L80 B20	5
	15° - 25° - 40° - 65°	>90
	IP 20	3000K - 4000K - TW - DTW - CCT 1800K/3000K
	90mm H 147mm	70 mm H 39mm

LUWEDREC1193040B	11W	40°	1750 lm	930	
LUWEDREC1493040B	14W	40°	2150 lm	930	
LUWEDREC1993040B	19W	40°	2850 lm	930	
LUWEDREC2393040B	23W	40°	3350 lm	930	

## OWWL



	O/F - Dali - BT	Incl.
	65.000h L80 B10	5
	Zoom 20° - 60°	>90 - >97
	IP 20	2700K - 3000K - 3500K - 4000K
	80x115mm H 195 mm	100

NE26122-0EZ2	12W	20° - 60°	1900 lm	930	
NE26122-0EZ3	18W	20° - 60°	2600 lm	930	
NE26122-0EZ4	25W	20° - 60°	3600 lm	930	
NE26122-0EZ5	33W	20° - 60°	4400 lm	930	

## SUTIL



	O/F - Dali - BT	Incl.
	65.000h L80 B10	5
	15° - 36° - 50°	>90
	IP 20	2700K - 3000K - 3500K - 4000K
	80mm H 150 mm	100

NE26011-1E32	12W	36°	1900 lm	930	
NE26011-1E33	18W	36°	2600 lm	930	
NE26011-1E34	25W	36°	3600 lm	930	
NE26011-1E35	33W	36°	4400 lm	930	

## SUTIL MINI



		O/F - Dali - BT		Incl.
		30.000h L80 B10		3
		30° - 40° - 55°		>90
		IP 20		CCT 2700K/3000K/4000K
		60mm H 145 mm		52

NE26015-1S30	8W	30°	790 lm	930	
NE26015-1S40	8W	40°	790 lm	930	
NE26015-1S50	8W	55°	790 lm	930	

## SUTIL MINI PRO



		O/F - Dali		Incl.
		50.000h L80 B20		5
		30° - 40° - 55°		>90
		IP 20		2700K - 3000K - 4000K
		60mm H 145 mm		52

NE26016-1H33	20W	30°	2548 lm	927	
NE26016-1E43	20W	40°	2548 lm	930	
NE26016-1F53	20W	55°	2548 lm	940	



## NEPAL 7 ROUND



	TRIAC		Incl.
	40.000h L80 B20		3
	24°		90
	IP 20		3000K
	60mm H 71mm		

HOF120001112	7W	24°	450 lm	930	
HOF120001212	7W	24°	450 lm	930	

## NEPAL



	O/F		Incl.
	40.000h L80 B20		3
	45°		>90
	IP 20		3000K
	~mm H ~mm		

HOF120021112	73mm H 100mm	12W	45°	780 lm	930	
HOF120021212		12W	45°	780 lm	930	
HOF120041112	94mm H 116mm	20W	45°	1300 lm	930	
HOF120041212		20W	45°	1300 lm	930	
HOF120061112	115mm H 125mm	30W	45°	1950 lm	930	
HOF120061212		30W	45°	1950 lm	930	

## BOGOTA ROUND GU10



			3
	IP 20		
	68mm H 95mm		

HOF120201190						
HOF120201290						

## SKA SM



		O/F - 1-10V - PC - CAS - Dali		Incl.
		100.000h L80 B20		5
		15° - 20° - 30° - 40° - 45° - 55° - 60°		>90 - 98 - 97
		IP 20		3000K - 4000K - B - M - F - V - R - CCT 1800K/3000K
		~mm H ~mm		

LUSKASMS99445W	160mm H 180mm	9,5W	45°	1450 lm	940	
LUSKASMS149445W		14W	45°	2150 lm	940	
LUSKASMS199445W		19W	45°	3050 lm	940	
LUSKASML99445W	220mm H 240mm	9,5W	40°	1550 lm	940	
LUSKASML149445W		14W	40°	2300 lm	940	
LUSKASML199445W		19W	40°	3050 lm	940	
LUSKASML239445W		23W	40°	3450 lm	940	
LUSKASML319445W		31W	40°	4300 lm	940	
LUSKASML409445W		40W	40°	5650 lm	940	

## BCN30 DOWN



		O/F - Dali		Incl.
		65.000h L80 B10		5
		15° - 25°		>90
		IP 20		2700K - 3000K - 4000K
		30mm H ~mm		60

NE06641-0E20	250mm	6W	25°	660 lm	930	
NE06642-0E20	350mm	6W	25°	660 lm	930	
NE06643-0E20	450mm	6W	25°	660 lm	930	

## BCN50 DOWN



		O/F - Dali		Incl.
		65.000h L80 B10		5
		20° - 40° - 60°		90
		IP 20		2700K - 3000K - 3500K - 4000K
		55mm H ~mm		

NE06601-1E40	180mm	6W	40°	760 lm	930	
NE06601-1E41		9W	40°	1030 lm	930	
NE06602-1E40	260mm	6W	40°	760 lm	930	
NE06602-1E41		9W	40°	1030 lm	930	
NE06603-1E40	340mm	6W	40°	760 lm	930	
NE06603-1E41		9W	40°	1030 lm	930	



## BCN90 DOWN



		O/F - Dali		Incl.
		65.000h L80 B10		5
		15° - 36° - 60°		>90
		IP 20		2700K - 3000K - 3500K - 4000K - B - M - F - V - R
		90mm H ~mm		

NE06611-1E62	250mm	12W	60°	1900 lm	930	
NE06611-1E63		18W	60°	2600 lm	930	
NE06611-1E64		25W	60°	3600 lm	930	
NE06612-1E62	350mm	12W	60°	1900 lm	930	
NE06612-1E63		18W	60°	2600 lm	930	
NE06612-1E64		25W	60°	3600 lm	930	
NE06612-1E65		33W	60°	4400 lm	930	

## BCN120 DOWN



		O/F - Dali		Incl.
		65.000h L80 B10		5
		15° - 36° - 60°		>90
		IP 20		2700K - 3000K - 3500K - 4000K - B - M - F - V - R
		120mm H ~mm		

NE06631-1E62	180mm	12W	60°	1950 lm	930	
NE06631-1E63		18W	60°	2700 lm	930	
NE06632-1E62	340mm	12W	60°	1950 lm	930	
NE06632-1E63		18W	60°	2700 lm	930	
NE06632-1E64		25W	60°	3700 lm	930	
NE06632-1E65		33W	60°	4500 lm	930	
NE06633-1E62	500mm	12W	60°	1950 lm	930	
NE06633-1E63		18W	60°	2700 lm	930	
NE06633-1E64		25W	60°	3700 lm	930	
NE06633-1E65		33W	60°	4500 lm	930	
NE06633-1E66		35W	60°	5800 lm	930	

## NEPAL 7 SQUARE



		TRIAC		Incl.
		40.000h L80 B20		3
		24°		>90
		IP 20		3000K
		60x60mm H 71mm		

HOF120011112		7W	24°	450 lm	930	
HOF120011212		7W	24°	450 lm	930	

## PLATINUM DOWN



		O/F		Incl.
		65.000h L80 B10		5
		20° - 40° - 60°		>90
		IP 20		2700K - 3000K - 4000K
		80x80mm H ~mm		

NE08396-0E60T	95mm	6W	60°	760 lm	930	
NE08396-1E60T		6W	60°	760 lm	930	
NE08396-2E60T		6W	60°	760 lm	930	
NE08397-0E60T	140mm	6W	60°	760 lm	930	
NE08397-1E60T		6W	60°	760 lm	930	
NE08397-2E60T		6W	60°	760 lm	930	
NE08398-0E60T	260mm	6W	60°	760 lm	930	
NE08398-1E60T		6W	60°	760 lm	930	
NE08398-2E60T		6W	60°	760 lm	930	
NE08398-0E61T		9W	60°	1030 lm	930	
NE08398-1E61T		9W	60°	1030 lm	930	
NE08398-2E61T		9W	60°	1030 lm	930	

## SQUARE



		O/F - Dali		Incl.
		65.000h L80 B10		5
		15° - 45°		>90
		IP 20		2700K - 3000K - 4000K
		~mm H ~mm		

NE18203-1E40	73x73mm H 95mm	7W	45°	950 lm	930	
NE18203-1E42		12,5W	45°	1400 lm	930	
NE18202-1E42	94x94mm H 110mm	12W	45°	1500 lm	930	
NE18202-1E43		17,5W	45°	2000 lm	930	
NE18201-1E43	115x115mm H 125mm	17,5W	45°	2000 lm	930	
NE18201-1E44		25W	45°	3000 lm	930	

## BOGOTA SQUARE GU10



IP 20

60x~mm H 95mm

HOF120231190

60mm

HOF120231290

HOF120241190

120mm

HOF120241290

## PARIS



O/F

40.000h L80 B20

35°

IP 20

105x38mm H 84mm



Incl.

3

90

2700K - 3000K

HOF120101111

7W

35°

404 lm

927

HOF120101112

7W

35°

440 lm

930

HOF120101211

7W

35°

404 lm

927

HOF120101212

7W

35°

440 lm

930



## BOGOTA SPOT GU10



		O/F - Dali		Incl.
		65.000h L80 B20		3
		15° - 36°		>90
		IP 20		2700K - 3000K - 3500K - 4000K
		68mm H 100mm		

HOF120211190

HOF120211290

## EYE DOWN



		O/F - Dali		Incl.
		65.000h L80 B20		5
		15° - 36°		>90
		IP 20		2700K - 3000K - 3500K - 4000K
		60mm H 93mm		

NE06203-1E33

18W 36° 2000 lm 930

NE06203-1E34

26W 36° 3000 lm 930

## WEDA SM



		O/F - Dali		Incl.
		100.000h L80 B20		5
		15° - 25° - 40° - 65°		>90 >98
		IP 20		3000K - 4000K - CCT 1800K-3000K
		95mm H 192mm		

LUWEDSM1193040B

11W 40° 1750 lm 930

LUWEDSM1493040B

14W 40° 2150 lm 930

LUWEDSM1993040B

19W 40° 2850 lm 930

LUWEDSM2393040B

23W 40° 3350 lm 930

## SUTIL MINI SURFACE



		O/F - Dali		Incl.
		30.000h L80 B20		3
		30° - 40° - 55°		>90
		IP 20		CCT 2700K/3000K/4000K - 2700K - 3000K - 4000K
		70mm H 190mm		

NE26025-0S30

8W 30° 790 lm 9~

NE26025-0S40

8W 40° 790 lm 9~

NE26025-0S50

8W 55° 790 lm 9~

## SUTIL MINI PRO SURFACE



		O/F - Dali		Incl.
		50.000h L80 B20		5
		30° - 40° - 55°		>90
		IP 20		CCT 2700K/3000K/4000K - 2700K - 3000K - 4000K
		130mm H 60mm		52

NE26026-0S33	20W	30°	2548 lm	9~	
NE26026-0S43	20W	40°	2548 lm	9~	
NE26026-0S53	20W	55°	2548 lm	9~	

## OWWL SURFACE



		O/F - Dali - PC		Incl.
		65.000h L80 B10		5
		Zoom 20° - 60°		>90
		IP 20		2700K - 3000K - 3500K - 4000K
		80mm H 240mm		

NE26132-0HZ2	12W	Zoom 20-60°	1900 lm	927	
NE26132-1EZ3	18W	Zoom 20-60°	2600 lm	930	
NE26132-1FZ4	25W	Zoom 20-60°	3600 lm	940	
NE26132-1WZ4	25W	Zoom 20-60°	3600 lm	935	

## BCN90



		O/F - Dali - BT		Incl.
		65.000h L80 B10		5
		15° - 36° - 60°		>90
		IP 20		3000K - 4000K - B - M - F - V - R - DTW - TW
		90x157mm H 202mm		

NE06512-0E32	12W	36°	1900 lm	930	
NE06512-0E33	18W	36°	2600 lm	930	
NE06512-0E34	25W	36°	3600 lm	930	
NE06512-0E35	33W	36°	4400 lm	930	



## SUTIL SURFACE



		O/F - Dali - PC		Incl.
		65.000h L80 B10		5
		15° - 36° - 50°		>90
		IP 20		2700K - 3000K - 3500K - 4000K
		82mm H 205mm		

NE26021-0E32	12W	36°	1900 lm	930	<input type="checkbox"/>
NE26021-0E33	18W	36°	2600 lm	930	<input type="checkbox"/>
NE26021-0E34	25W	36°	3600 lm	930	<input type="checkbox"/>

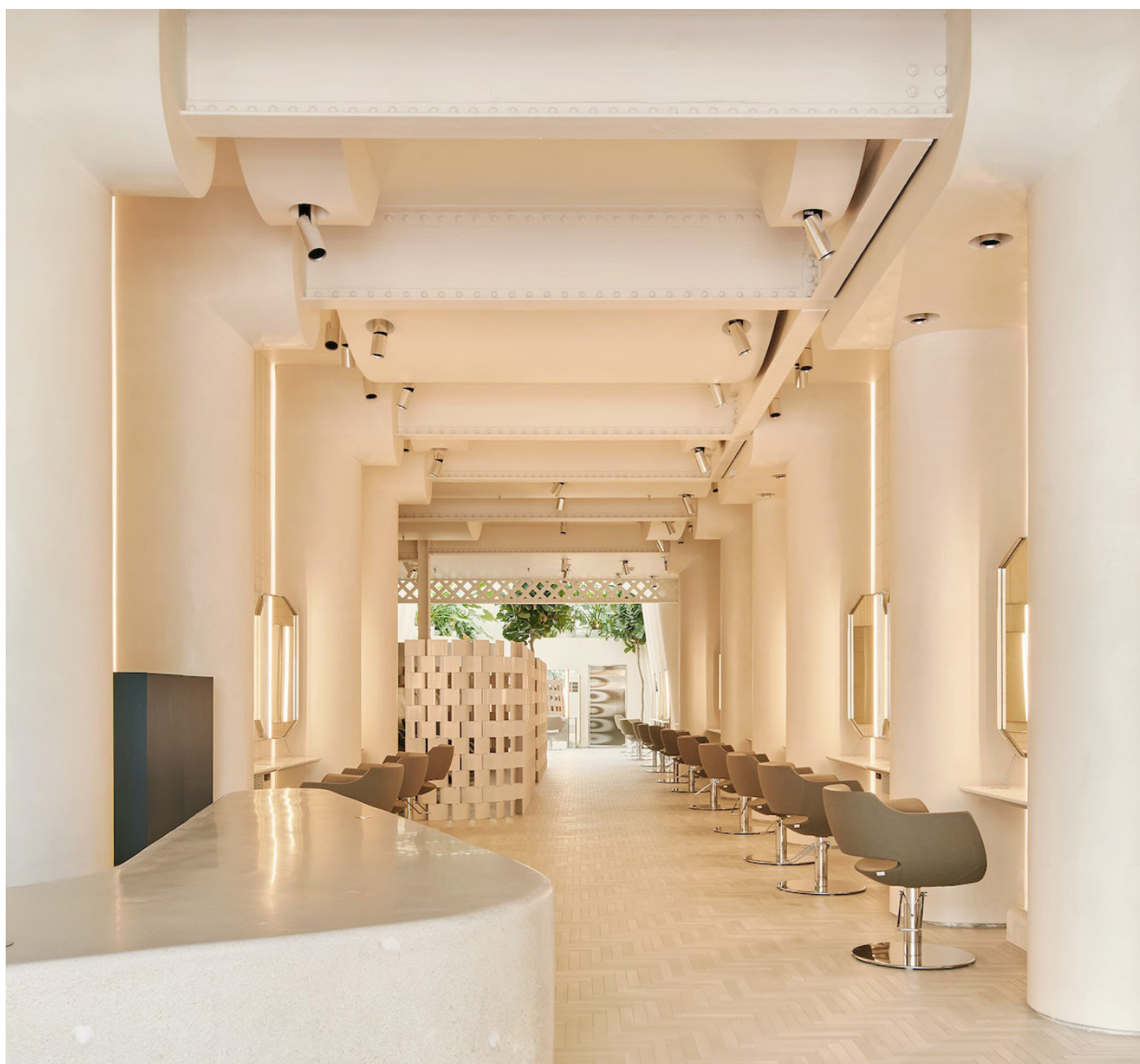

## TIRES DOWN



		O/F - Dali - BT		Incl.
		50.000h L80 B20		5
				>90
		IP 20		2700K - 3000K - 4000K
		~mm H ~mm		

NE31420-MMH3	350mm H 97mm	21W	2150 lm	927	
NE31430-JJE2	500mm H 129mm	14W	1900 lm	930	
NE31430-JJE3	500mm H 129mm	21W	2500 lm	930	
NE31440-EEH3	700mm H 128,5mm	21W	2500 lm	927	
NE31440-EEE4	700mm H 128,5mm	29W	3500 lm	930	

## IBIZA 15/18/32



		O/F		Incl.
		35.000h		3
		110°		>80
		IP 65		CCT 2700K/3200K/4000K
		~mm H 65mm		

HOF120301118	280mm	10-15W	110°	1045/1525 lm	8~	
HOF120311118	360mm	13-18W	110°	1220/1790 lm	8~	
HOF120321118	410mm	22-32W	110°	2125/3150 lm	8~	
<b>Extra</b>						
HOF120308101	OST	1,5m				

## IBIZA 15 SENSOR



		O/F		Incl.
		35.000h		3
		110°		>80
		IP 65		CCT 2700K/3200K/4000K
		280mm H 62mm		

HOF120351118		10-15W	110°	1045/1525 lm	8~	
<b>Extra</b>						
HOF120308101	OST	1,5m				

## LITHUANIA GEN 2



		O/F		Incl.
		50.000h		3
		120°		>80
		IP 65		CCT 2700K/3000K/4000K
		300mm H 54mm		

HOF220501118	13-18W	120°	1220/1905 lm	8~	
HOF220501318	13-18W	120°	1220/1905 lm	8~	

## HOL DOWN



		O/F		Incl.
		35.000h L80 B20		3
		100°		>80
		IP 54 / IP 20		CCT 2700K/3000K/4000K
		200 mm H 77mm		

NE01920-0S93	21W	100°	2900 lm	8~	
NE01920-1S93	21W	100°	2900 lm	8~	

## HOLP DOWN



		O/F - Dali - PC		Incl.
		65.000h L80 B10		5
		100		>80
		IP 54 / IP 20		CCT 2700K/3000K/4000K
		200 mm H 77mm		

NE01925-0S93	21W	100°	2950 lm	8~	
NE01925-1S93	21W	100°	2950 lm	8~	

## TECTORUM



C



R

		O/F		Incl.
		30.000h L70 B10		3
		120°		>80
		IP 65 / IK 10		CCT 3000K/4000K/5700K
		~mm H ~mm		













TLTCT1318CCCT	C	280x280x50mm	13-18W	120°	1359/2052 lm	8~	
TLTCT1318RCCT	R	280x50mm	13-18W	120°	159/2052 lm	8~	









## BRUSSELS















		O/F - 1-10V - Dali		Incl.
		50.000h L80 B10		3
		90°		>83
		IP 20		CCT 3000K/3500K/4000K
		~mm H ~mm		

HOF120256118	450mm H 103mm	26W	90°	2630/ 2720/ 2760 lm	8~	
HOF120256218		26W	90°	2630/ 2720/ 2760 lm	8~	
HOF120266118	600mm H 105mm	40W	90°	4120/ 4230/ 4340 lm	8~	
HOF120266218		40W	90°	4120/ 4230/ 4340 lm	8~	

## LATVIA



		O/F		Incl.
		50.000h L80 B10		3
		110°		>80
		IP 54		3000K
		270x270mm H 53mm		

HOF220511112		25W	110°	2050 lm	830	
HOF220511312		25W	110°	2050 lm	830	

## ASTA



		O/F - 1-10V - Dali - BT		Incl.
		80.000h L80 B50		5
		AS		>80
		IP 20		2700K - 3000K - 4000K - 5700K - 6500K
		~mm H ~mm		

MOASTA480084	1195x100mm H 60mm	38W	AS	4800 lm	840	
MOASTA650084	1486x100mm H 67mm	47W	AS	6500 lm	840	

## AREL

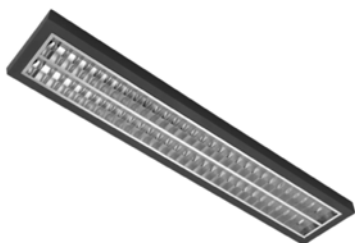

		O/F - 1-10V - Dali - BT		Incl.
		80.000h L80 B50		5
		60°		>80 - >90
		IP 20		2700K - 3000K - 4000K - 5700K - 6500K
		~mm H 55mm		

MOAREL3800294G	1245x245mm	37W	60°	3800 lm	940	
MOAREL5400284G	1545x245mm	41W	60°	5400 lm	840	

## AREL AS



	O/F - Dali - BT		Incl.
	80.000h L80 B50		5
	AS		>80
	IP 20		2700K - 3000K - 4000K - 5700K - 6500K
	~mm H 55mm		

MOARAS450084	1245x245mm	37W	AS	4500 lm	840	
MOARAS620084	1545x245mm	47W	AS	6200 lm	840	

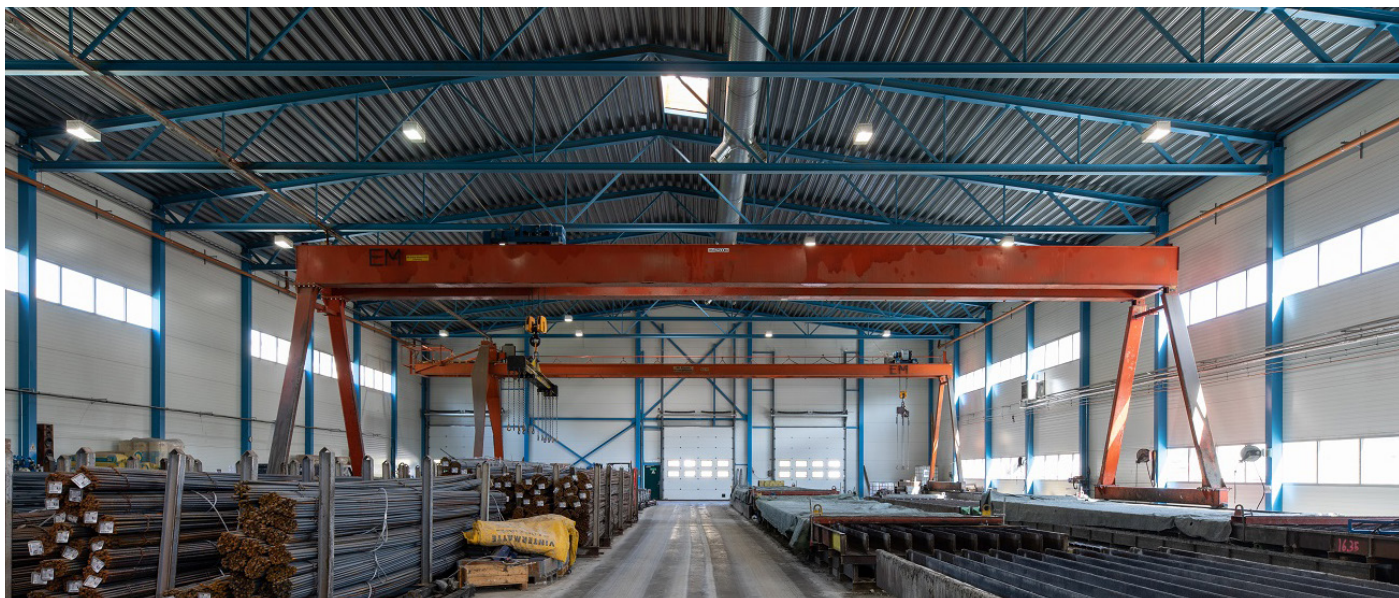

## EPK



R1



S2

	O/F - 1-10V - Dali - BT		Incl.
	80.000h L80 B50		5
	90°		>80 - >90
	IP 40		2700K - 3000K - 4000K - 5700K - 6500K
	~mm H 40 mm		

MOEPK1900R184	R1	655x295mm	15W	90°	1900 lm	840	
MOEPK1950S184	R1	595x595mm	15W	90°	1950 lm	840	
MOEPK2650S184	S1		20W	90°	2650 lm	840	
MOEPK2800S284	S2		19W	90°	2800 lm	840	
MOEPK4100S284	S2		30W	90°	4100 lm	840	
MOEPK6000S284	S2		48W	90°	6000 lm	840	
MOEPK4200R184	R1	1230x225mm	28W	90°	4200 lm	840	
MOEPK5900R184	R1		51W	90°	5900 lm	840	
MOEPK4400R184	R1	1535x225mm	34W	90°	4400 lm	840	
MOEPK5800R184	R1		46W	90°	5800 lm	840	
MOEPK3351R184	R1	1230x295mm	33-51W	90°	3900-5600 lm	840	

## EPD

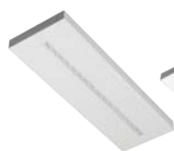

R1



S3



R2



S2

	O/F - 1-10V - Dali - BT		Incl.
	80.000h L80 B50		5
	90°		>80 - >90
	IP 20		2700K - 3000K - 4000K - 5700K - 6500K
	~mm H 40 mm		

MOEPD1000R0584	R0	375x225mm	8W	90°	1000 lm	840	
MOEPD1300R0584	R0		10W	90°	1300 lm	840	
MOEPD2000R184	R1	655x225mm	14W	90°	2000 lm	840	
MOEPD3800R284	R2		27W	90°	3800 lm	840	
MOEPD2000S184	S1	595x595mm	14W	90°	2000 lm	840	
MOEPD3800S284	S2		27W	90°	3800 lm	840	
MOEPD4000S384	S3		25W	90°	4000 lm	840	
MOEPD3800R184	R1	1230x225mm	27W	90°	3800 lm	840	
MOEPD5900R284	R2		41W	90°	5900 lm	840	
MOEPD7700R284	R2		54W	90°	7700 lm	840	

# INFINITY DOWN



		O/F - Dali - BT		Incl.
		65.000h L80 B10		5
		110°		>90
		IP 43		2700K - 3000K - 4000K - TW
		40x~mm H 80mm		

NE16102-1EL	577mm	12W	110°	1800 lm	930	
NE16102-1EH		22W	110°	3300 lm	930	
NE16103-1EL	857mm	18W	110°	2700 lm	930	
NE16103-1EH		33W	110°	4950 lm	930	
NE16104-1EL	1137mm	24W	110°	3600 lm	930	
NE16104-1EH		44W	110°	6600 lm	930	
NE16105-1EL	1417mm	30W	110°	4500 lm	930	
NE16105-1EH		55W	110°	8250 lm	930	
NE16106-1EL	1697mm	36W	110°	5400 lm	930	
NE16106-1EH		66W	110°	9900 lm	930	
NE16107-1EL	1977mm	42W	110°	6300 lm	930	
NE16107-1EH		77W	110°	11550 lm	930	
NE16108-1EL	2257mm	48W	110°	7200 lm	930	
NE16108-1EH		88W	110°	13200 lm	930	
NE16109-1EL	2537mm	54W	110°	8100 lm	930	
NE16109-1EH		99W	110°	14850 lm	930	
NE16110-1EL	2817mm	60W	110°	9000 lm	930	
NE16110-1EH		110W	110°	16500 lm	930	



## INFINITY DOT



		O/F - Dali - BT		Incl.
		65.000h L80 B10		5
		12° - 34° - 48°		>90
		IP 20		2700K - 3000K - 4000K
		40x~mm H 80mm		

Model	Length	Power	Beam Angle	Lumen	Color Temp	Beam Spread	Color
NE16602-1E11	578mm	10W	12°	1240 lm	930		
NE16602-1E13		20W	12°	2100 lm	930		
NE16603-1E12	858mm	15W	12°	1860 lm	930		
NE16603-1E14		30W	12°	3150 lm	930		
NE16604-1E13	1138mm	20W	12°	2480 lm	930		
NE16604-1E18		40W	12°	4200 lm	930		
NE16605-1E14	1418mm	25W	12°	3100 lm	930		
NE16605-1E16		50W	12°	5250 lm	930		
NE16606-1E14	1698mm	30W	12°	3720 lm	930		
NE16606-1E17		60W	12°	6300 lm	930		
NE16607-1E15	1978mm	35W	12°	4340 lm	930		
NE16607-1E18		70W	12°	7350 lm	930		
NE16608-1E15	2258mm	40W	12°	4960 lm	930		
NE16608-1E19		80W	12°	8400 lm	930		
NE16609-1E16	2538mm	45W	12°	5580 lm	930		
NE16609-1E19		90W	12°	9450 lm	930		
NE16610-1E17	2818mm	50W	12°	6200 lm	930		
NE16610-1E19		100W	12°	10500 lm	930		

## INFINITY DOWN DOT



		O/F - Dali		Incl.
		65.000h L80 B10		5
		12° - 34° - 48°		>90
		IP 20		2700K - 3000K - 4000K
		40x~mm H 80mm		

Model	Length	Power	Beam Angle	Lumen	Color Temp	Beam Spread	Color
NE16651-1E40	207mm	5W	48°	620 lm	930		
NE16651-1E41		10W	48°	1050 lm	930		
NE16652-1E41	337mm	10W	48°	1240 lm	930		
NE16652-1E43		20W	48°	2100 lm	930		

## LINE SUSPENDED



		O/F		Incl.
		50.000h L80 B20		5
		120°		>90
		IP 20		2700K - 3000K - 4000K
		19mm H ~mm		

NE31155-1E1	562mm	9,6W	120°	1440 lm	930	
NE31157-1E1	762mm	13,5W	120°	2016 lm	930	

## PISA



		O/F		Incl.
		30.000h		3
		38°		>90
		IP 20		3000K
		27mm H 450mm		

HOF121001112		7,5W	38°	255 lm	930	
HOF121001212		7,5W	38°	255 lm	930	

## BOGOTA PENDANT GU10



				3
		IP 20		
		68mm H 250mm		

HOF120221190						
HOF120221290						

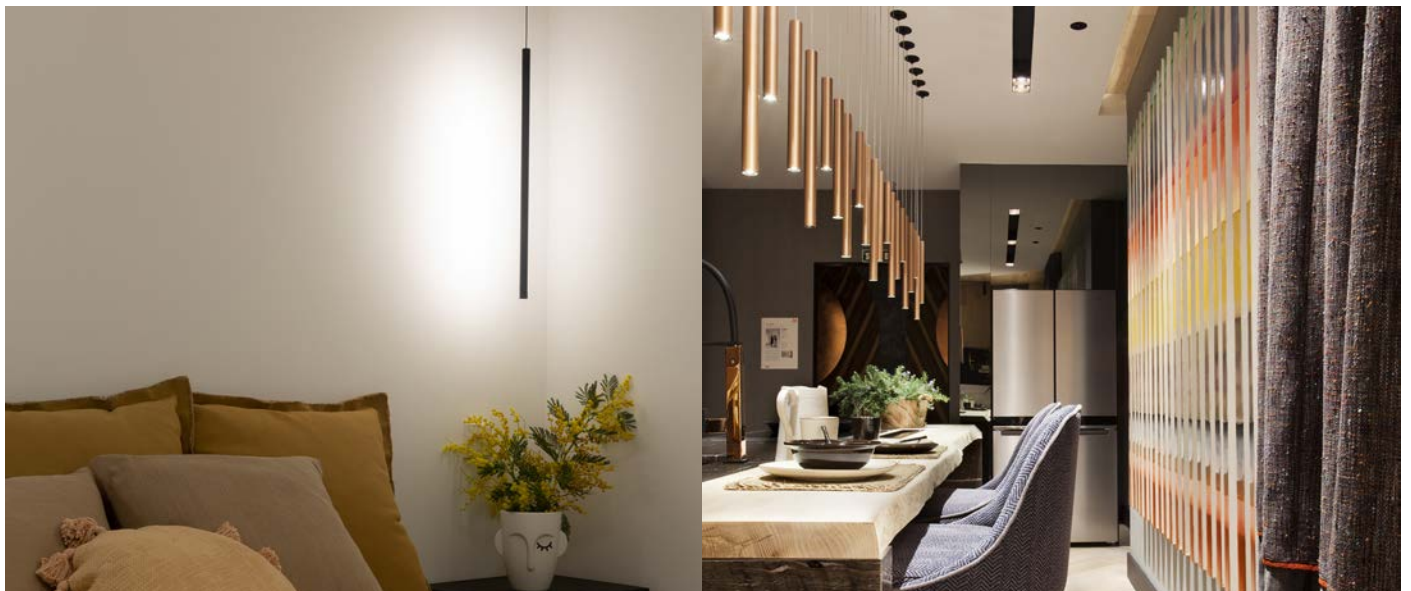

## BCN30 AIR



		O/F - Dali		Incl.
		65.000h L80 B10		5
		15° - 25°		>90
		IP 20		2700K - 3000K - 4000K
		30mm H ~mm		60

NE06741-1E20	250mm	6W	25°	660 lm	930	
NE06742-1E20	350mm	6W	25°	660 lm	930	
NE06743-1E20	450mm	6W	25°	660 lm	930	

## BCN50 AIR



		O/F - PC - Dali		Incl.
		65.000h L80 B10		5
		20° - 40° - 60°		>90
		IP 20		CCT 1800K/3000K - 2700K - 3000K - 3500K - 4000K
		55mm H ~mm		

NE06701-1E60	180mm	6W	60°	760 lm	930	
NE06701-1E61		9W	60°	1030 lm	930	
NE06702-1E60	260mm	6W	60°	760 lm	930	
NE06702-1E61		9W	60°	1030 lm	930	
NE06703-1E60	350mm	6W	60°	760 lm	930	
NE06703-1E61		9W	60°	1030 lm	930	

## BCN90 AIR



		O/F - Dali		Incl.
		65.000h L80 B10		5
		15° - 36° - 60°		>90
		IP 20		2700K - 3000K - 3500K - 4000K - B - M - F - V - R
		90mm H ~mm		

NE06711-1E2	260mm	12W	60°	1900 lm	930	
NE06711-1E63		18W	60°	2600 lm	930	
NE06711-1E64		25W	60°	3600 lm	930	
NE06712-1E62	350mm	12W	60°	1900 lm	930	
NE06712-1E63		18W	60°	2600 lm	930	
NE06712-1E64		25W	60°	3600 lm	930	
NE06712-1E65		33W	60°	4400 lm	930	

# BCN120 AIR



		O/F - Dali		Incl.
		65.000h L80 B10		5
		15° - 36° - 60°		>90
		IP 20		2700K - 3000K - 4000K B - M - F - V - R
		120mm H ~mm		

NE06731-1E62	180mm	12W	60°	1950 lm	930	
NE06731-1E63		18W	60°	2700 lm	930	
NE06732-1E62	350mm	12W	60°	1950 lm	930	
NE06732-1E63		18W	60°	2700 lm	930	
NE06732-1E64		25W	60°	3700 lm	930	
NE06732-1E65		33W	60°	4500 lm	930	
NE06733-1E62	500mm	12W	60°	1950 lm	930	
NE06733-1E63		18W	60°	2700 lm	930	
NE06733-1E64		25W	60°	3700 lm	930	
NE06733-1E65		33W	60°	4500 lm	930	
NE06733-1E66		35W	60°	5800 lm	930	



## TIRES I



		O/F - Dali		Incl.
		50.000h L80 B10		5
		120°		>90
		IP 20		2700K - 3000K
		192mm H 96mm		

NE31310-JE1

12W

1300 lm

930



## TIRES II



		O/F - Dali		Incl.
		50.000h L80 B10		5
		120°		>90
		IP 20		2700K - 3000K
		192mm H 155mm		

NE31320-JJE1

12W

1300 lm

930



## TIRES III



		O/F - Dali		Incl.
		50.000h L80 B10		5
		120°		>90
		IP 20		2700K - 3000K
		350mm H 97mm		

NE31330-JJE1

12W

1300 lm

930



## TIRES IV



		O/F - Dali		Incl.
		50.000h L80 B10		5
		120°		>90
		IP 20		2700K - 3000K
		350mm H 156mm		

NE31340-JJSE1

12W

1300 lm

930



# TIRES V (ACOUSTIC)



		O/F - Dali		Incl.
		50.000h L80 B10		5
		120°		>90
		IP 20		2700K - 3000K
	480mm H 164mm			

NE31350-JJDE1

12W

1300 lm

930





## MINIM SINGLE AIR UP/DOWN DOT

			O/F - Dali		Incl.
			65.000h L80 B10		5
			110°		>90
			IP 20		2700K - 3000K - 4000K
			36mm H 27mm		
NE27460-1E6	1258mm	48W	6888 lm	930	
NE27462-CF7	1508mm	58W	8338 lm	940	
NE27464-BF8	1758mm	68W	9788 lm	940	
NE27466-JF9	2008mm	78W	11238 lm	940	

## INFINITY AIR



		O/F - Dali - BT		Incl.
		65.000 L80 B10		5
		110°		>90
		IP 20 - IP 43		CCT 2700K/6500K 2700K - 3000K - 4000K
		40x~mm H 80mm		

NE16122-1EL	577mm	12W	110°	1800 lm	930	
NE16122-1EH		22W	110°	3300 lm	930	
NE16123-1EL	857mm	18W	110°	2700 lm	930	
NE16123-1EH		33W	110°	4950 lm	930	
NE16124-1EL	1137mm	24W	110°	3600 lm	930	
NE16124-1EH		44W	110°	6600 lm	930	
NE16125-1EL	1417mm	30W	110°	4500 lm	930	
NE16125-1EH		55W	110°	8250 lm	930	
NE16126-1EL	1697mm	36W	110°	5400 lm	930	
NE16126-1EH		66W	110°	9900 lm	930	
NE16127-1EL	1977mm	42W	110°	6300 lm	930	
NE16127-1EH		77W	110°	11550 lm	930	
NE16128-1EL	2257mm	48W	110°	7200 lm	930	
NE16128-1EH		88W	110°	13200 lm	930	
NE16129-1EL	2537mm	54W	110°	8100 lm	930	
NE16129-1EH		99W	110°	14850 lm	930	
NE16130-1EL	2817mm	60W	110°	9000 lm	930	
NE16130-1EH		110W	110°	16500 lm	930	
<b>Extra</b>						
NE17936				SD 2500mm		
NE17942-1				VK 1500mm		
NE17943-1				VK 2500mm		
NE17944-1				VK 2500mm		

## INFINITY AIR DIRECT-INDIRECT



		O/F - Dali - BT		Incl.
		65.000 L80 B10		5
		110°		>90
		IP 20		2700K - 3000K - 4000K
		40x~mm H 80mm		

NE16303-1EL	857mm	30W	110°	4500 lm	930	
NE16304-1EL	1137mm	42W	110°	6300 lm	930	
NE16305-1EL	1417mm	48W	110°	7200 lm	930	
NE16307-1EL	1977mm	72W	110°	10800 lm	930	
NE16309-1EL	2537mm	84W	110°	12600 lm	930	
NE16310-1EL	2817mm	90W	110°	13500 lm	930	

## BOW 650



	O/F		Incl.
	50.000h L80 B20		5
			>80
	IP 20		2700K
	106mm H 650mm		

NE31130-1G1

10W

1000 lm

827



## BOW 1200

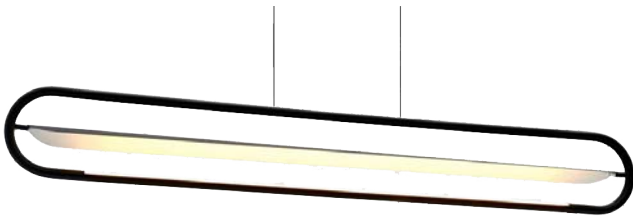

	O/F - Dali		Incl.
	50.000h L80 B20		5
			>80
	IP 20		2700K
	1200mm H 160mm		

NE31125-1G3

21W

2370 lm

827



## MOBILE 600 (ACOUSTIC)

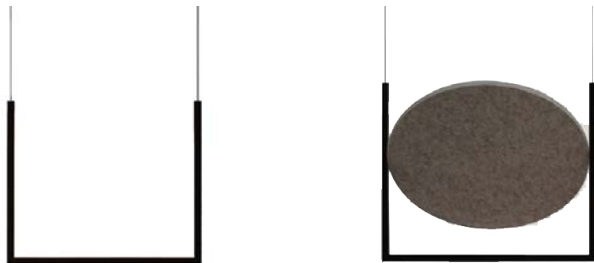

	O/F - Dali		Incl.
	50.000h L80 B20		5
	90°		>80
	IP 20		2700K - 3000K
	600mm H 500mm		

NE31210-1C2

17W

90°

1230 lm

830



NE31211-1SC2

17W

90°

1230 lm

830



## MOBILE 1200 (ACOUSTIC)



	O/F - Dali		Incl.
	50.000h L80 B20		5
	90°		>80
	IP 20		2700K - 3000K
	1200mm H 302/350mm		

NE31225-1C4

34W

90°

2500 lm

830



NE31226-1SC4

34W

90°

2500 lm

830







## AROS SINGLE

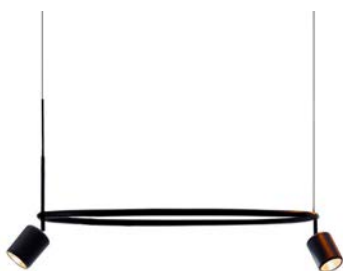

NE31512-1C2

		O/F		Incl.
		50.000h L80 B20		5
		90°+36°		>80
		IP 20		3000K
		820mm H 1500mm		

34+15W 90°+36° 4090+1240 lm 830

## AROS DOUBLE



NE31523-1C3

		O/F		Incl.
		50.000h L80 B20		5
		90°		>80
		IP 20		3000K
		820x1370mm H 1500mm		

61W 90° 6830 lm 830

## AROS TRIPLE



NE31535-1C3

		O/F		Incl.
		50.000h L80 B20		5
		90°		>80
		IP 20		3000K
		820x2170mm H 1500mm		

61+22W 90° 6830+1860 lm 830

## INOT OCC



		O/F - Dali		Incl.
		60.000h L80 B10		5
		110°		>80
		IP 40		3000K - 4000K
		13mm H 33mm		

HEINOTOCCS702083	700mm	20W	1633 lm	830	
HEINOTOCCS903583	900mm	35W	3200 lm	830	
HEINOTOCCS1205083	1200mm	50W	5100 lm	830	
HEINOTOCCS1507083	1500mm	70W	6400 lm	830	

## INOT ICC



		O/F - Dali		Incl.
		60.000h L80 B10		5
		110°		>80
		IP 40		3000K - 4000K
		~mm H ~mm		

HEINOTICCS702083	700mm	20W	1633 lm	830	
HEINOTICCS903583	900mm	35W	3200 lm	830	
HEINOTICCS1205083	1200mm	50W	5100 lm	830	
HEINOTICCS1507083	1500mm	70W	6400 lm	830	

## SLENDER CC-S / S



		O/F - Dali		Incl.
		60.000h L80 B10		5
		110°		>80
		IP 40		3000K - 4000K
		15mm H 52mm		

HESLENDER703583	700mm	35W	900 lm	830	
HESLENDER907083	900mm	70W	1700 lm	830	
HESLENDER12010583	1200mm	105W	2600 lm	830	
HESLENDER150010583	1500mm	105W	2700 lm	830	



## SLENDER-DI



		O/F - Dali		Incl.
		60.000h L80 B10		5
		110°		>80
		IP 40		3000K - 4000K
		15mm H 52mm		

HESLENDERDI703583	700mm	35W	900 lm	830	
HESLENDERDI907083	900mm	70W	1700 lm	830	
HESLENDERDI12010583	1200mm	105W	2600 lm	830	
HESLENDERDI150010583	1500mm	105W	2700 lm	830	

## CORIDOR E-S

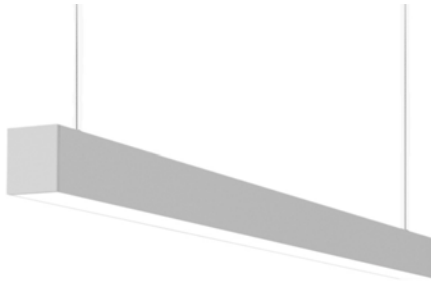

		1-10V - Dali		Incl.
		60.000h L80 B10		5
		110°		>80
		IP 40		3000K - 4000K
		60mm H 70mm		

HECORES601383	600mm	13W	950 lm	830	
HECORES1202183	1200mm	21W	1900 lm	830	
HECORES1803083	1800mm	30W	2860 lm	830	
HECORES2404083	2400mm	40W	3800 lm	830	

## CORIDOR N-S



		1-10V - Dali		Incl.
		60.000h L80 B10		5
		110°		>80
		IP 40		2700K - 6500K
		40mm H 65mm		

HECORN602083	600mm	20W	1600 lm	830	
HECORN902583	900mm	25W	2500 lm	830	
HECORN1203583	1200mm	35W	3400 lm	830	
HECORN1504083	1500mm	40W	4200 lm	830	
HECORN1805083	1800mm	50W	5100 lm	830	
HECORN2006083	2000mm	60W	6000 lm	830	
HECORN2407083	2400mm	70W	6400 lm	830	
HECORN3209583	3200mm	95W	9300 lm	830	

## VALO



		1-10V - Dali		Incl.
		60.000h L80 B10		5
		120°		>80
		IP 40		2700K - 6500K
		150mm		

HEVALOS6020	20W	1900 lm	830	
HEVALOS9025	25W	2700 lm	830	
HEVALOS12035	35W	3800 lm	830	
HEVALOS15040	40W	4700 lm	830	

## CORIDOR S

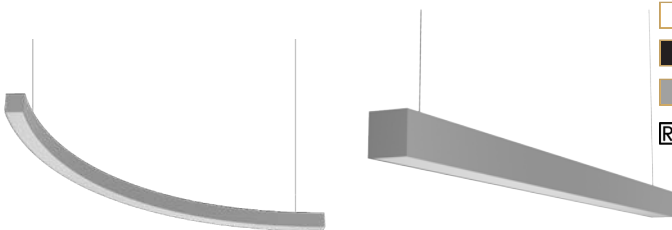

		O/F - 1-10V - Dali		Incl.
		60.000h L80 B10		5
		90°		>80
		IP 40		3000K - 4000K - CCT 2700K/6500K
		~x76mm H 80mm		

HECOSS8R10254W	875mm	25W	90°	1951 lm	840	
HECOSS9254W	900mm	25W	90°	1951 lm	840	
HECOSS12354W	1200mm	35W	90°	2601 lm	840	
HECOSS15404W	1500mm	40W	90°	3251 lm	840	
HECOSS17R25504W	1750mm	50W	90°	3902 lm	840	
HECOSS18504W	1800mm	50W	90°	3902 lm	840	
HECOSS24704W	2400mm	70W	90°	5485 lm	840	
HECOSS26754W	2600mm	75W	90°	5852 lm	840	

## CORIDOR NX



		O/F - 1-10V - Dali - TW		Incl.
		60.000h L80 B10		5
		90°		>80
		IP 40		3000K - 4000K - CCT 2700K/6500K
		~mm H 65mm		

HECONXS126214W	1200x600mm	2x21W 2x13W	90°	5664 lm	840	
HECONXS1212214W	1200x1200mm	4x21W	90°	6607 lm	840	
HECONXS156254W	1500x600mm	2x25W 2x13W	90°	7551 lm	840	



## M-LINE T

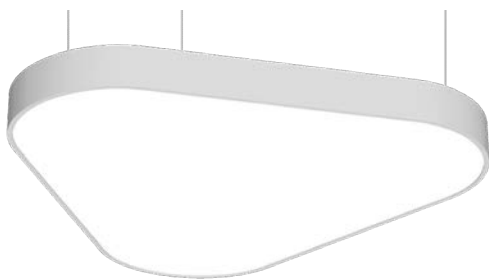

		O/F - 1-10V - Dali		Incl.
		60.000h L80 B10		5
		90°		>80
		IP 40		3000K - 4000K - CCT 2700K/6500K
		~mm H ~mm		

HETS89704W	900mm H 80mm	70W	90°	6488 lm	840	
HETS891054W		105W	90°	9093 lm	840	
HETS8121054W	1200mm H 80mm	105W	90°	10916 lm	840	
HETS8121404W		140W	90°	14234 lm	840	
HETS19704W	900mm H 111mm	70W	90°	6488 lm	840	
HETS191054W		105W	90°	9093 lm	840	
HETS1121054W	1200mm H 111mm	105W	90°	10916 lm	840	
HETS1121404W		140W	90°	14234 lm	840	

## M-LINE C



		O/F - 1-10V - Dali		Incl.
		60.000h L80 B10		5
		90°		>80
		IP 40		3000K - 4000K - CCT 2700K/ 6500K
		~mm H 35/55/80/111mm		

HEMCS83204W	350mm H 80mm	20W	90°	2400 lm	840	
HEMCS83254W		25W	90°	3557 lm	840	
HEMCS84254W	450mm H 80mm	25W	90°	4000 lm	840	
HEMCS84354W		35W	90°	4788 lm	840	
HEMCS86354W	600mm H 80mm	35W	90°	4894 lm	840	
HEMCS86704W		70W	90°	9022 lm	840	
HEMCS89704W	900mm H 80mm	105W	90°	11240 lm	840	
HEMCS8121404W	1200mm H 80mm	140W	90°	14257 lm	840	
HEMCS8152104W	1500mm H 80mm	210W	90°	17588 lm	840	



# M-LINE CC

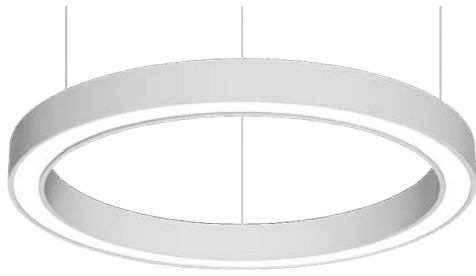

		O/F - 1-10V - Dali		Incl.
		60.000h L80 B10		5
		90°		>80
		IP 40		3000K - 4000K - CCT 2700K/ 6500K
		~mm H 35/55/80/111mm		

HECCS87354W	700mm H 80mm	35W	90°	3108 lm	840	<input type="checkbox"/>
HECCS87704W		70W	90°	6034 lm	840	<input type="checkbox"/>
HECCS12704W	1200mm H 80mm	70W	90°	6323 lm	840	<input type="checkbox"/>
HECCS121054W		105W	90°	9440 lm	840	<input type="checkbox"/>
HECCS151054W	1500mm H 80mm	105W	90°	9484 lm	840	<input type="checkbox"/>
HECCS151404W		140W	90°	12213 lm	840	<input type="checkbox"/>
HECCS181404W	1800mm H 80mm	140W	90°	12483 lm	840	<input type="checkbox"/>
HECCS201404W	2000mm H 80mm	140W	90°	12488 lm	840	<input type="checkbox"/>
HECCS301754W	3000mm H 80mm	175W	90°	15036 lm	840	<input type="checkbox"/>
HECCS402404W	4000mm H 80mm	240W	90°	23380 lm	840	<input type="checkbox"/>
HECCS503504W	5000mm H 80mm	350W	90°	31353 lm	840	<input type="checkbox"/>



# INFINITY WALL UP/DOWN



		O/F - Dali - BT		Incl.
		65.000h L80 B10		5
		110°		>90
		IP 20		2700K - 3000K - 4000K
		~x40mm H 80mm		

NE16412-1EL	577mm	18W	2700 lm	930	
NE16413-1EL	857mm	30W	4500 lm	930	
NE16414-1EL	1137mm	42W	6300 lm	930	

# CORIDOR HN (WALL)



		O/F - 1-10V - Dali		Incl.
		60.000h L80 B10		5
		110°		>80
		IP 40		3000K - 4000K - CCT 2700K/6500K
		~x72mm H 85mm		

HECOHNDI7204W	700mm	15/ 20W	2290/ 2459 lm	840	
HECOHNDI10254W	1000mm	25/ 20W	3435/ 2459 lm	840	
HECOHNDI13354W	1300mm	35/ 20W	4580/ 2459 lm	840	



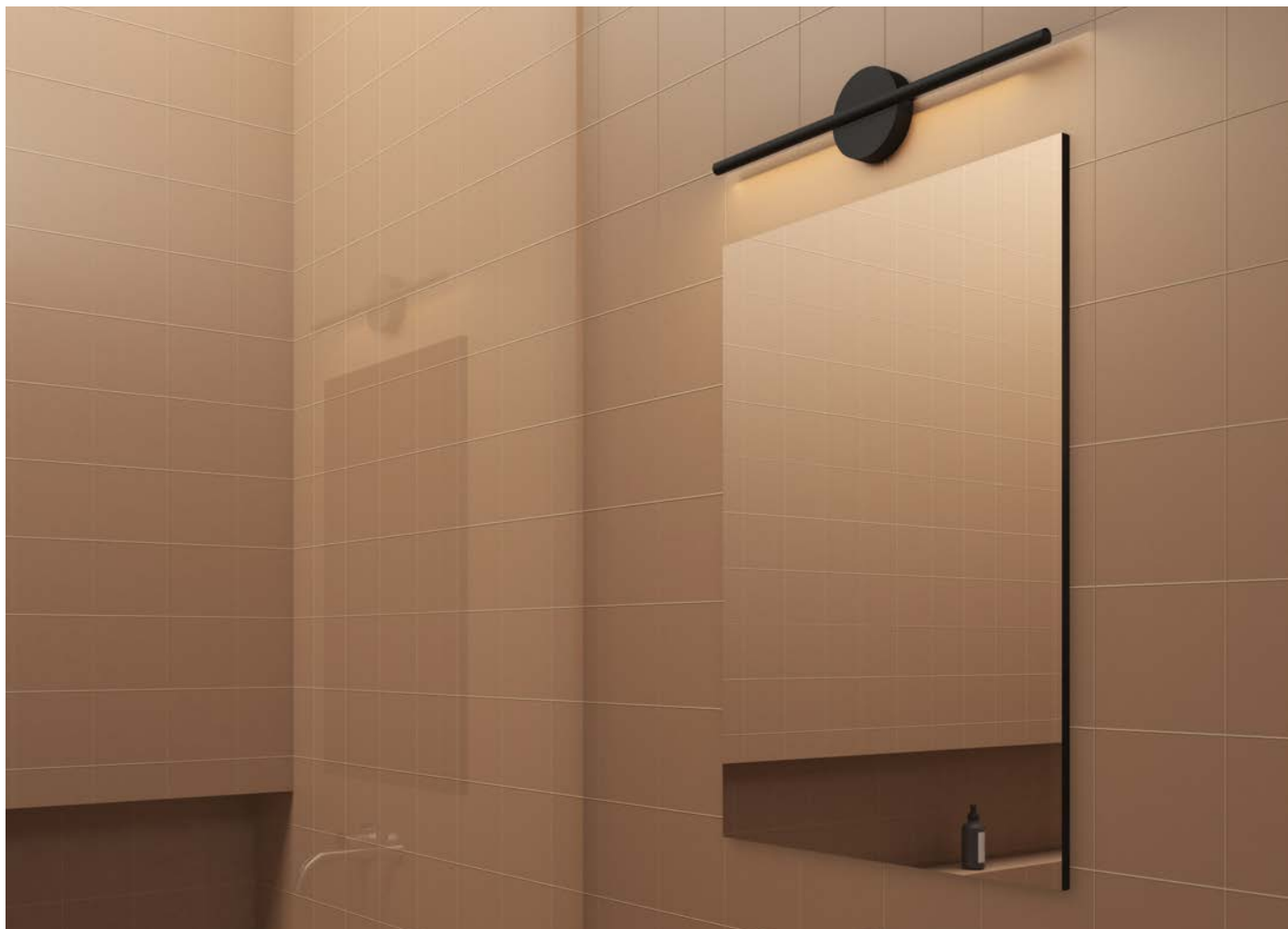

## LINE WALL

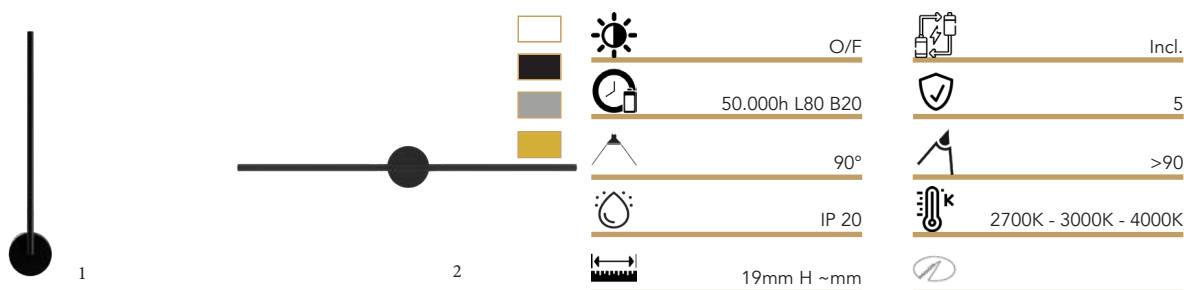

NE31175-1E1	1	600mm	9,6W	1440 lm	930	
NE31177-1E1	1	850mm	14,4W	2160 lm	930	
NE31182-1E1	2	600mm	8W	1152 lm	930	
NE31185-1E1	2	1200mm	19,2W	2880 lm	930	

## AROS WALL

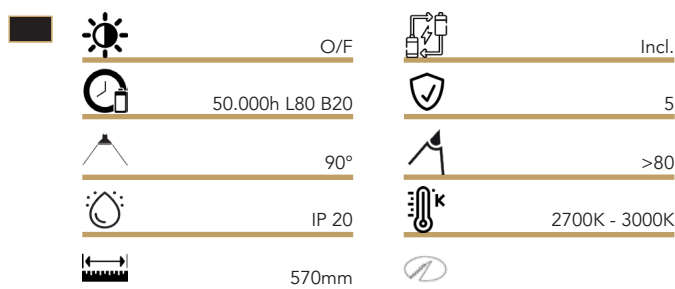

NE31501-1C2

27W

2740 lm

830





LEDSTRIP  
RUBAN LED



## TOP STICK LED



	O/F - 1-10V		Excl.
	60.000h L70 B10		3
	100°		>95
	IP 20		3000K - 4000K
	40x~mm H 12mm		

HA610 014 201 02	310mm	7,5W	110°	1302 lm/m	930	
HA610 014 202 02	610mm	15W	110°	1302 lm/m	930	
HA610 014 203 02	910mm	22,5W	110°	1302 lm/m	930	
HA610 014 204 02	1210mm	30W	110°	1302 lm/m	930	

## TOP STICK LED SENSOR



	O/F - 1-10V		Excl.
	60.000h L70 B10		3
	110°		>95
	IP 20		3000K - 4000K
	40x~mm H 12mm		

HA610 014 251 02	450mm	7,1W	110°	1100 lm/m	930	
HA610 014 252 02	600mm	10,1W	110°	1100 lm/m	930	
HA610 014 253 02	900mm	15,6W	110°	1100 lm/m	930	
HA610 014 254 02	1200mm	20,9W	110°	1100 lm/m	930	

## TOP STICK LED ASYMMETRIC



	O/F - 1-10V		Excl.
	60.000h L70 B10		3
	AS		>95
	IP 20		3000K - 4000K
	40x~mm H 12mm		

HA610 014 221 02	310mm	7,5W	100°	1302 lm/m	930	
HA610 014 222 02	610mm	15W	100°	1302 lm/m	930	
HA610 014 223 02	910mm	22,5W	100°	1302 lm/m	930	
HA610 014 224 02	1210mm	30W	100°	1302 lm/m	930	

## LED PIPE



	O/F - 1-10V - Dali		Excl.
	50.000h L70 B10		3
	100°		>95
	IP 20		2700K - 3000K - 4000K
	14x~mm H 20mm		

HA610 014 911 02	310mm	7,5W	100°	458 lm	930	
HA610 014 912 02	610mm	15W	100°	915 lm	930	
HA610 014 913 02	910mm	22,5W	100°	1373 lm	930	
HA610 014 904 02	1210mm	30W	100°	1830 lm	930	

<b>Extra</b>						
HA215 300 610 01					AK 1m	
HA215 300 625 01					AK 2m	
HA213 010 101 52					MH	





## LED DRIVER



HA206 040 023 01	5W	6 way
HA206 040 011 01	15W	12 way
HA206 040 012 01	30W	12 way
HA206 040 031 01	60W	12 way
HA206 040 019 01	75W	12 way
HA206 040 033 01	100W	12 way
HA206 040 040 01	150W	12 way

## LED FLOODSTRIP DOTFREE



	O/F - Dali - DMX		Incl.
	60.000h L90 B10		5
	110°		80
	IP 66		2700K - 3000K - 4000K - 6000K - RGBW
	~mm H mm		

MCI7433014802K7	1000mm	17,6W	80 leds	891 lm	827
MCI7433014803K	1000mm	17,6W	80 leds	940 lm	830
MCI7433014804K	1000mm	17,6W	80 leds	990 lm	840
MCI743301806K	1000mm	17,6W	80 leds	1086 lm	860
MCI743304114K	1000mm	17,6W	80 leds	1060 lm	RGBW

# ECOLITE F



	O/F		Incl.
	50.000h L70 B10		3
	170°		>80
	IP 20		3000K - 4000K
	27,5x~mm H 40mm		

HA20202980102	300 mm	4W	170°	300 lm	830	
HA20202980202	600 mm	7W	170°	600 lm	830	
HA20202980302	900mm	11W	170°	900 lm	830	
HA20202980402	1150mm	14W	170°	1150 lm	830	
HA20202980502	1420mm	18W	170°	1420 lm	830	

## Extra

HA21548031801	HK 1800mm
HA21548060101	AK 150mm
HA21548060301	AK 300mm
HA21548060601	AK 600mm
HA21548061201	AK 1200mm
HA21548061801	AK 1800mm
HA21548131801	HK 1800 mm
HA21548160101	AK 150mm
HA21548160301	AK 300 mm
HA21548160601	AK 600 mm
HA21548161201	AK 1200 mm
HA21548161801	AK 1800mm



## SLIMLITE CS LED



	O/F - 1-10V		Incl.
	60.000h L70 B10		3
	110°		>95
	IP 20		2700K - 3000K - 4000K - M
	29x~mm H 42,4mm		

HA610 012 920 04	335mm	5,8W	110°	580 lm	927	<input type="checkbox"/>
HA610 012 920 02		5,8W	110°	580 lm	930	<input type="checkbox"/>
HA610 012 920 01		5,8W	110°	580 lm	940	<input type="checkbox"/>
HA610 012 941 02	595mm	5,8W	110°	580 lm	930	<input type="checkbox"/>
HA610 012 941 03		5,8W	110°	580 lm	940	<input type="checkbox"/>
HA610 012 942 02	895mm	8,9W	110°	890 lm	930	<input type="checkbox"/>
HA610 012 942 03		8,9W	110°	890 lm	940	<input type="checkbox"/>
HA610 012 943 02	1195mm	10,3W	110°	1030 lm	930	<input type="checkbox"/>
HA610 012 943 03		10,3W	110°	1030 lm	940	<input type="checkbox"/>
HA610 012 921 04	595mm	13,8W	110°	1380 lm	927	<input type="checkbox"/>
HA610 012 921 02		13,8W	110°	1380 lm	930	
HA610 012 921 01		13,8W	110°	1380 lm	940	
HA610 012 931 02		13,8W	110°	1380 lm	930	dim
HA610 012 931 03		13,8W	110°	1380 lm	940	dim
HA610 012 941 05		13,8W	110°	1380 lm	95M	
HA610 012 922 04	895mm	18W	110°	1800 lm	927	
HA610 012 922 02		18W	110°	1800 lm	930	
HA610 012 922 01		18W	110°	1800 lm	940	
HA610 012 942 05		18W	110°	1800 lm	95M	
HA610 012 932 02		18W	110°	1800 lm	930	dim
HA610 012 932 03		18W	110°	1800 lm	940	dim
HA610 012 923 04	1195mm	24,7W	110°	2470 lm	927	
HA610 012 923 02		24,7W	110°	2470 lm	930	
HA610 012 923 01		24,7W	110°	2470 lm	940	
HA610 012 943 05		24,7W	110°	2470 lm	95M	
HA610 012 933 02		24,7W	110°	2470 lm	930	dim
HA610 012 933 03		24,7W	110°	2470 lm	940	dim
Extra						
HA215 260 218 01				VK 1800mm		
HA215 260 230 01				VK 3000mm		
HA215 260 318 01				VK 1800mm		
HA215 260 405 01				VK 500mm		
HA215 260 418 01				VK 1800mm		
HA215 260 601 01				AK 150mm		
HA215 260 603 01				AK 300mm		
HA215 260 606 01				AK 600 mm		
HA215 260 000 01				C		

## MICRO LINE GRAZER



	O/F - DMX		Excl.
	60.000h L80 B10		3
	120°		>80
	IP 66		3000K - 4000K - RGBW
	~mm H ~mm		

MCI74101004803K	1000mm	12W	120°	980 lm	830	
MCI74101004804K	1000mm	12W	120°	1030 lm	840	
MCI74101504113K	1000mm	12W	120°	505 lm	RGBW	

## MINI LINE GRAZER



	O/F - DMX		Excl.
	60.000h L80 B10		3
	10x60°		>80
	IP 66		3000K - 4000K - RGBW
	~mm H ~mm		

MCI75002104803K	1000mm	72W	10x60°	6920 lm	830	
MCI75002104804K	1000mm	72W	10x60°	7270 lm	840	
MCI75002504113K	1000mm	72W	10x60°	3630 lm	RGBW	



## LED STRIP 230V PRO



	O/F		Excl.
	30.000h L70		3
	120°		>80
	IP 65		3000K - 4000K - 6000K
	14x~mm H 7,4mm		

TLHV15P660L5	50m	15W/m	120°	1830 lm/m	860	100mm
TLHV15P640LM	1m	15W/m	120°	1830 lm/m	840	100mm
TLHV15P630L5	50m	15W/m	120°	1830 lm/m	830	100mm

## LED STRIP 230V SAGRADA FAMILIA



	PC		
	40.000h L80 B20		4
	120°		>80
	IP 65		2700K - 3000K - 4000K
	12mmx~m H 4mm		

NE21411SP-G/m		7W/m	120°	635 lm/m	827	200mm
NE21411SP-C/m		7W/m	120°	665 lm/m	830	200mm
NE21411SP-N/m		7W/m	120°	700 lm/m	840	200mm
NE21412SP-G/m		15W/m	120°	1355 lm/m	827	100mm
NE21412SP-C/m		15W/m	120°	1425 lm/m	830	100mm
NE21412SP-N/m		15W/m	120°	1460 lm/m	840	100mm

## LED STRIP 24V COLOSSEO 66



	O/F		Excl.
	40.000h L80 B20		3
	120°		>80
	IP 66		2700K - 3000K - 4000K
	~x5000mm H ~mm		

NE21131-G	8mm H 2mm	4,8W/m	120°	560 lm/m	827	100mm
NE21131-C		4,8W/m	120°	575 lm/m	830	100mm
NE21131-N		4,8W/m	120°	590 lm/m	840	100mm
NE21132-G	8mm H 4mm	9,6W/m	120°	1110 lm/m	827	50mm
NE21132-C		9,6W/m	120°	1140 lm/m	830	50mm
NE21132-N		9,6W/m	120°	1160 lm/m	840	50mm
NE21233-G	12mm H 4mm	14,4W/m	120°	1400 lm/m	827	33mm
NE21233-C		14,4W/m	120°	1450 lm/m	830	33mm
NE21233-N		14,4W/m	120°	1480 lm/m	840	33mm
NE21134-G		19,2W/m	120°	1960 lm/m	827	25mm
NE21134-C		19,2W/m	120°	2010 lm/m	830	25mm
NE21134-N		19,2W/m	120°	2050 lm/m	840	25mm

## LED STRIP 24V BROOKLYN 67



	O/F		Excl.
	50.000h		3
	120°		>90
	IP 67		2700K - 3000K - 4000K
	~x5000mm H 4mm		

NE21151-H	10mm	4,8W/m	120°	530 lm/m	927	100mm
NE21151-E		4,8W/m	120°	550 lm/m	930	100mm
NE21151-F		4,8W/m	120°	570 lm/m	940	100mm
NE21152-H		9,6W/m	120°	1050 lm/m	927	50mm
NE21152-E		9,6W/m	120°	1080 lm/m	930	50mm
NE21152-F		9,6W/m	120°	1120 lm/m	940	50mm
NE21153-H	12mm	14,4W/m	120°	1340 lm/m	927	33mm
NE21153-E		14,4W/m	120°	1380 lm/m	930	33mm
NE21153-F		14,4W/m	120°	1420 lm/m	940	33mm
NE21154-H		19,2W/m	120°	2150 lm/m	927	29,4mm
NE21154-E		19,2W/m	120°	2170 lm/m	930	29,4mm
NE21154-F		19,2W/m	120°	2260 lm/m	940	29,4mm

## LED STRIP 24V NOTRE DAME RGBW 67



	O/F		Excl.
	40.000h		5
	120°		
	IP 67		RGB 3000K - 4000K - 6000K
	14x5000mm H 4mm		

NE15544-24		19,2W/m	120°	850 lm/m	RGB 30	100mm
NE15786-24		19,2W/m	120°	880 lm/m	RGB 40	100mm
NE15543-24		19,2W/m	120°	930 lm/m	RGB 60	100mm

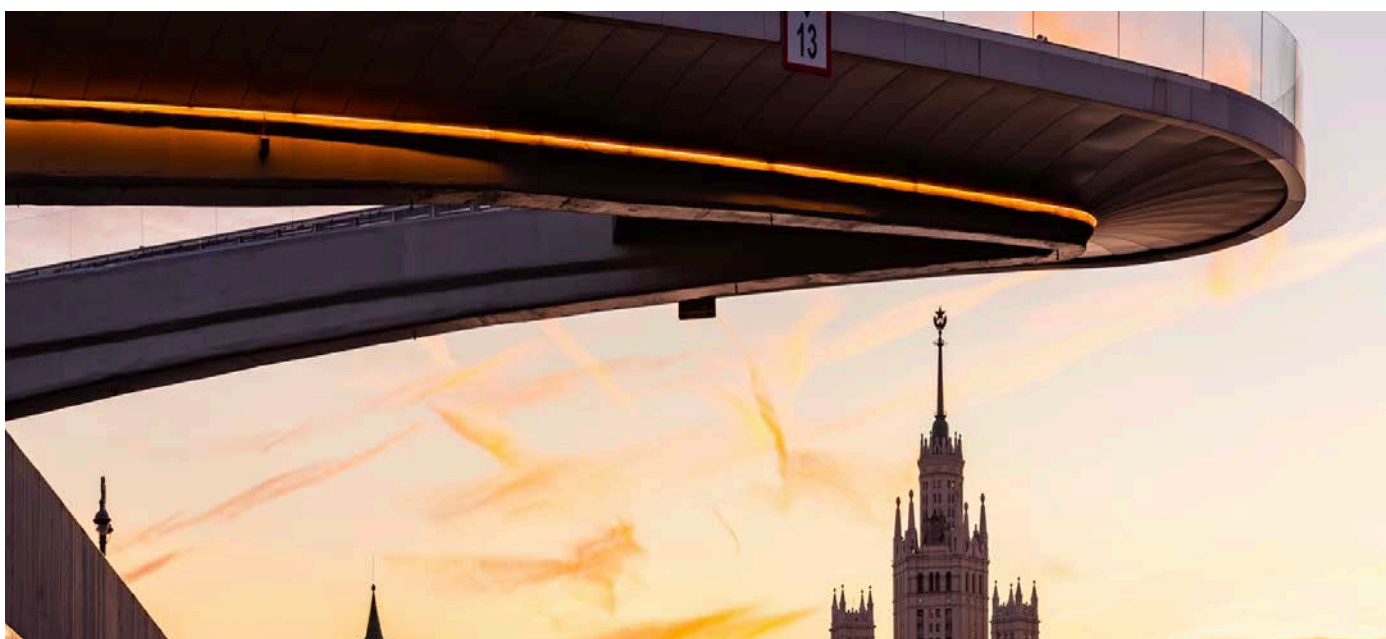

## LED STRIP 24V GOLDEN GATE



	O/F		Excl.
	40.000h		5
	120°		>80
	IP 20		2700K - 3000K - 4000K
	~x5000mm H 2mm		

NE21071-G	10mm	10,5W/m	120°	1600 lm/m	827	125mm
NE21071-C		10,5W/m	120°	1790 lm/m	830	125mm
NE21071-N		10,5W/m	120°	1900 lm/m	840	125mm
NE21072-G		21W/m	120°	3190 lm/m	827	62,5mm
NE21072-C		21W/m	120°	3520 lm/m	830	62,5mm
NE21072-N		21W/m	120°	3620 lm/m	840	62,5mm
NE21073-G	12mm	40W/m	120°	5780 lm/m	827	33,3mm
NE21073-C		40W/m	120°	6190 lm/m	830	33,3mm
NE21073-N		40W/m	120°	6430 lm/m	840	33,3mm

## LED STRIP 24V ALHAMBRA



	O/F		Excl.
	40.000h		5
	120°		>98
	IP 20		2700K - 3000K - 4000K
	8x5000mm H 2mm		

NE21081-H		9,6W/m	120°	1008 lm/m	927	50mm
NE21081-E		9,6W/m	120°	1104 lm/m	930	50mm
NE21081-F		9,6W/m	120°	1200 lm/m	940	50mm

## LED STRIP 24V TRAFALGAR SQUARE



	O/F		Excl.
	40.000h		3
	120°		>90
	IP 20		2700K - 3000K - 4000K
	8x5000mm H 2mm		

NE21091-H		11W/m	120°	950 lm/m	927	62,5mm
NE21091-E		11W/m	120°	1010 lm/m	930	62,5mm
NE21091-F		11W/m	120°	1110 lm/m	940	62,5mm

## LED STRIP 24V TRAFALGAR SQUARE FREE CUT



	O/F		Excl.
	35.000h L80 B20		3
			>90
	IP 20		2700K - 3000K - 4000K
	8x5000mm H 4mm		

NE21092-H	13W/m	820 lm/m	927	FREE CUT
NE21092-E	13W/m	890 lm/m	930	FREE CUT
NE21092-F	13W/m	910 lm/m	940	FREE CUT

## LED LONG ISLAND 48V



	O/F		Excl.
	50.000h L80 B20		5
			>90
	IP 67		2700K - 3000K - 4000K
	12x5000mm H 4mm		

NE21611-H/50	4,8W/m	420 lm/m	927	166,7
NE21611-E/50	4,8W/m	430 lm/m	930	166,7
NE21611-F/50	4,8W/m	450 lm/m	940	166,7

## LED STRIP 24V TIMES SQUARE



	O/F		Excl.
	40.000h		3
	120°		>90
	IP 20		2700K - 3000K - 4000K
	13,5x5000mm H 2mm		

NE15506-24	15W/m	120°	1400 lm/m	927	100mm
NE15507-24	15W/m	120°	1500 lm/m	930	100mm
NE15508-24	15W/m	120°	1600 lm/m	940	100mm



## LED STRIP 24V PICADILLY MINI



	O/F		Excl.
	40.000h		3
	120°		>90
	IP 20		2700K - 3000K - 4000K
	4x5000mm H 2mm		

NE21021-H	14,4W/m	120°	1080 lm/m	927	35,7mm
NE21021-E	14,4W/m	120°	1120 lm/m	930	35,7mm
NE21021-F	14,4W/m	120°	1150 lm/m	940	35,7mm

## LED STRIP 24V NOTRE DAME RGBW



	O/F		Excl.
	40.000h		5
	120°		
	IP 20		RGB 3000K - 4000K - 6000K
	12x5000mm H 2mm		

NE15546-24	19,2W/m	120°	850 lm/m	RGB 30	100mm
NE15785-24	19,2W/m	120°	880 lm/m	RGB 40	100mm
NE15499-24	19,2W/m	120°	930 lm/m	RGB 60	100mm

## LED STRIP 24V BROOKLYN



	O/F		Excl.
	40.000h		3
	120°		>90
	IP 20		2700K - 3000K - 4000K
	~x5000mm H 2mm		

NE21051-H	8mm	4,8W/m	120°	540 lm/m	927	100mm
NE21051-E		4,8W/m	120°	560 lm/m	930	100mm
NE21051-F		4,8W/m	120°	580 lm/m	940	100mm
NE21052-H	8mm	9,6W/m	120°	1090 lm/m	927	50mm
NE21052-E		9,6W/m	120°	1100 lm/m	930	50mm
NE21052-F		9,6W/m	120°	1160 lm/m	940	50mm
NE21053-H	10mm	14,4W/m	120°	1370 lm/m	927	33mm
NE21053-E		14,4W/m	120°	1390 lm/m	930	33mm
NE21053-F		14,4W/m	120°	1450 lm/m	940	33mm
NE21054-H	10mm	19,2W/m	120°	2230 lm/m	927	29,4mm
NE21054-E		19,2W/m	120°	2300 lm/m	930	29,4mm
NE21054-F		19,2W/m	120°	2360 lm/m	940	29,4mm



## LED STRIP 24V COLOSSEO



	O/F		Excl.
	40.000h		3
	120°		>80
	IP 20		2700K - 3000K - 4000K
	~x5000mm H 2mm		

Model	Height	Power (W/m)	Beam Angle	Lumen (lm/m)	Length (mm)	Width (mm)
NE21031-G	8mm	4,8W/m	120°	585 lm/m	827	100mm
NE21031-C		4,8W/m	120°	600 lm/m	830	100mm
NE21031-N		4,8W/m	120°	615 lm/m	840	100mm
NE21032-G	8mm	9,6W/m	120°	1150 lm/m	827	50mm
NE21032-C		9,6W/m	120°	1190 lm/m	830	50mm
NE21032-N		9,6W/m	120°	1220 lm/m	840	50mm
NE21033-G	10mm	14,4W/m	120°	1450 lm/m	827	33mm
NE21033-C		14,4W/m	120°	1480 lm/m	830	33mm
NE21033-N		14,4W/m	120°	1500 lm/m	840	33mm
NE21034-G		19,2W/m	120°	1990 lm/m	827	25mm
NE21034-C		19,2W/m	120°	2050 lm/m	830	25mm
NE21034-N		19,2W/m	120°	2100 lm/m	840	25mm

## LED STRIP 24V ACROPOLIS



	O/F		Excl.
	40.000h		5
	120°		>90
	IP 20		2700K - 3000K - 4000K
	15x5000mm H 2mm		

Model	Power (W/m)	Beam Angle	Lumen (lm/m)	Length (mm)	Width (mm)
NE15770-24	38,4W/m	120°	2700 lm/m	927	13mm
NE15771-24	38,4W/m	120°	2800 lm/m	930	13mm
NE15772-24	38,4W/m	120°	2900 lm/m	940	13mm

## LED STRIP 24V CENTRAL PARK RGB



	O/F		Excl.
	40.000h		5
	120°		
	IP 20		RGB
	10x5000mm H 2mm		

NE15530-24	7,2W/m	120°	RGB	166mm
NE15547-24	10W/m	120°	RGB	100mm

## LED STRIP PETRA RGBW



	O/F		Excl.
	40.000h		5
	120°		
	IP 20		RGB - 2700K
	10x5000mm H 2mm		

NE15780-05	18W/m	120°	RGB 827	16,7mm
------------	-------	------	---------	--------

## LED STRIP BIG BEN TW



	O/F		Excl.
	40.000h		5
	120°		
	IP 20		CCT 2900K/6500K
	10x5000mm H 2mm		

NE15596-24	19,2W/m	120°	600/700 lm/m	829-865	100mm
------------	---------	------	--------------	---------	-------

## LED STRIP 24V BRANDERBURGER TW



	O/F		Excl.
	40.000h		5
	120°		
	IP 20		CCT 2400K/6500K
	14x5000mm H 2mm		

NE21211	24W/m	120°	1440 lm/m	824-865	100mm
---------	-------	------	-----------	---------	-------

## LED STRIP DRIVER 230V - 24V



NE15060-24MW		12W	IP30	90x40x29mm
NE15061-24MW		36W	IP42	84x57x30mm
NE15063-24MW		60W	IP67	163x43x32mm
NE15064-24MW		100W	IP67	190x52x37mm
NE15069-24MW		150W	IP67	223x39x68mm
NE15070-24MW		320W	IP67	223x39x68mm
NE15505-24	NOOD	30W		
NE15082	Dali/DMX	3x48W		

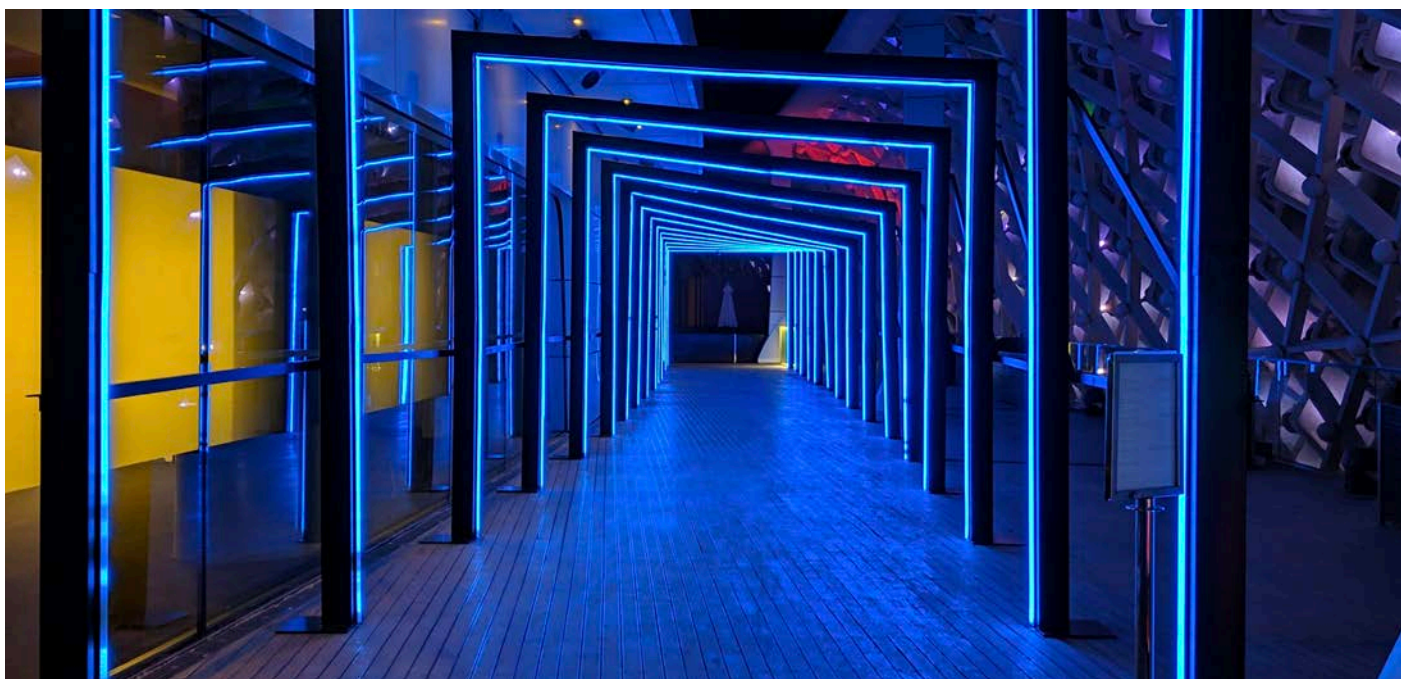

## SMARTLED FLEX 3D 24V



	O/F		Excl.
	50.000h L80 B10		5
	110°		>90
	IP 67		2700K - 3000K - 3500K - 4000K - 5000K
	16x3/5m H 15mm		

MCI7320000853K	30 000mm	9,6W/m	110°	500 lm	930	50mm
MCI7320000854K		9,6W/m	110°	520 lm	940	50mm

## SMART LED FLEX 24V



	PWM - DMX		Excl.
	50.000h L80 B10		5
	105°		
	IP 67		3000K - RGBW
	16mm H 17mm		

MCI732100113K	1	5000mm	19,2W/m	105°	25 lm/m	RGBW	<input type="checkbox"/>
MCI732200113K	2	5000mm	19,6W/m	105°	18 lm/m	RGBW pixel	<input type="checkbox"/>

## SMARTLED FLEX LENS 3D 24V



	PWM		Excl.
	50.000h L80 B10		5
	30° - 15x40°		>90
	IP 67		3000K - 4000K - RGBW
	24mm H 18mm		

MCI7325005903K		5000mm	26W/m	30°	63 lm/W	930
MCI7325005904K		5000mm	26W/m	30°	69 lm/W	940
MCI7326005113K		5000mm	24W/m	30°	53 lm/W	RGBW

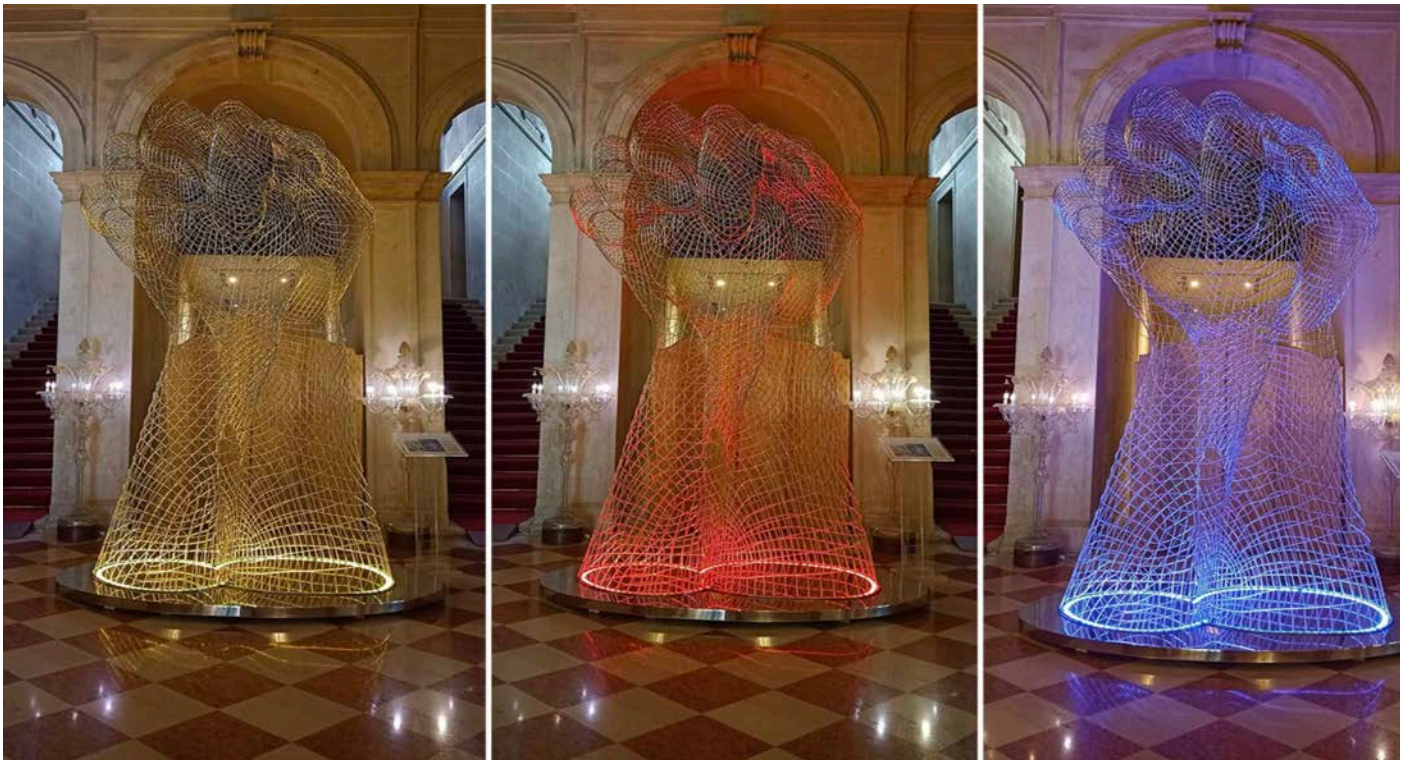



## NEON TOP 24V



	DIM		Excl.
	50.000h		5
	120°		>80
	IP 65		2700K - 3000K - 4000K - 6000K
	6mm H 6mm		

TLNF72F62VLM	7,2W/m	120°	622 lm/m	827
TLNF72F63VLM	7,2W/m	120°	622 lm/m	830
TLNF72F64VLM	7,2W/m	120°	622 lm/m	840

## NEON SIDE 24V



	DIM		Excl.
	50.000h		5
	120°		>80
	IP 65		2700K - 3000K - 4000K - 6000K - RGBK
	6mm H 15mm		

TLNF77L62VLM	7,7W/m	120°	405 lm/m	827
TLNF77L63VLM	7,7W/m	120°	410 lm/m	830
TLNF77L64VLM	7,7W/m	120°	426 lm/m	840

## NEON 360 24V



	DIM		Excl.
	50.000h		5
	360°		>80
	IP 65		2700K - 3000K - 4000K - 6000K - RGBK
	1000mm H 20mm		

TLNF12C6236M	12W/m	360°	1430 lm/m	827
TLNF12C6336M	12W/m	360°	1440 lm/m	830
TLNF12C6436M	12W/m	360°	1500 lm/m	840

## PROFILE ALU SURFACE 180°



NE15667-8200	20x20mm / 17mm	2000mm	
<b>Extra</b>			
NE15692		EC	
NE15694-200		OD 2000mm	
NE15695-200		TD 2000mm	

## PROFILE ALU ROUND



NE15653-8200	24mm / 12,2mm	2000mm	
<b>Extra</b>			
NE15673		EC	
NE15664		OST	
NE15682-200		OD 2000mm	
NE15683-200		TD 2000mm	

## OKOA PROFILE



TLPF0430TBAN	30x2000mm	incl. cover, clips, endcap	
TLPF0430TBNE		incl. cover, clips, endcap	
TLPF0430TBBL		incl. cover, clips, endcap	

## NILE PROFILE

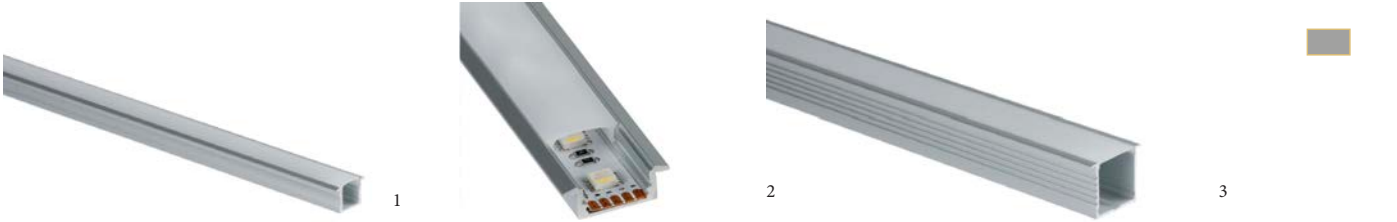

TLPF2314EMAN	1	23x14mm	2000mm	Incl. cover, clips, endcap	
TLPF2314EMNE	1		2000mm	Incl. cover, clips, endcap	
TLPF2314EMBL	1		2000mm	Incl. cover, clips, endcap	
TLPF2508EMAN	2	23x9mm	2000mm	Incl. cover, clips, endcap	
TLPF2508EMNE	2		2000mm	Incl. cover, clips, endcap	
TLPF2508EMBL	2		2000mm	Incl. cover, clips, endcap	
TLPF4435EMAN	3	44x35mm	2000mm	Incl. cover, clips, endcap	
TLPF4435EMNE	3		2000mm	Incl. cover, clips, endcap	
TLPF4435EMBL	3		2000mm	Incl. cover, clips, endcap	



## PROFILE LEAN



	1		2	3	
TLPF2929CLAN	1	29,80x29,80 mm	2000mm	Incl. cover, clips, endcap	
TLPF2929CLNE	1		2000mm	Incl. cover, clips, endcap	
TLPF2929CLBL	1		2000mm	Incl. cover, clips, endcap	
TLPF2930CLAN	2	29,80x29,80 mm	2000mm	Incl. cover, clips, endcap	
TLPF2930CLNE	2		2000mm	Incl. cover, clips, endcap	
TLPF2930CLBL	2		2000mm	Incl. cover, clips, endcap	
TLPF5074CLAN	3	50,2x75mm	2000mm	Incl. cover, clips, endcap	
TLPF5074CLNE	3		2000mm	Incl. cover, clips, endcap	
TLPF5074CLBL	3		2000mm	Incl. cover, clips, endcap	



## PROFILE MINI RECESSED



NE22002-8200	6,2mm x 7mm	2000mm		
Extra				
NE22302-200		OC2000mm		
NE22505		EC		

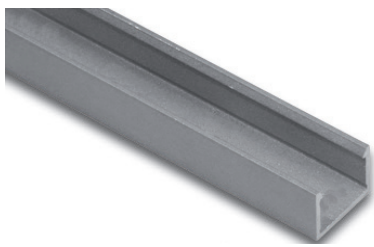



## PROFILE LED MOUNTING



HA615 000 316 10	15x11,8mm	1000mm		
Extra				
HA615 000 316 61		5 P x 2950mm		
HA615 000 310 21		EC 2		
HA202 040 117 01		MCL 2		
HA203 012 805 10		HMCV 1000mm		
HA203 012 805 54		HMCV 6000mm		

## PROFILE LED BUILT-IN



HA615 000 314 10	24x15mm	1000mm	
HA615 000 314 61		5 P x 2950mm	
HA615 000 310 11		EC 2	
HA203 012 805 10		HMCV 1000mm	
HA203 012 805 54		HMCV 6000mm	
HA615 000 315 10	34x25mm	1000mm	
HA615 000 315 61		5 P x 2950mm	
HA615 000 310 01		EC 2	
HA203 012 803 10		HMCV 1000mm	
HA203 012 803 54		HMCV 5400mm	
<b>Extra</b>			
HA615 000 311 01		DK 5000mm	
HA615 000 305 01		MT 5000mm	

## PROFILE IN CEILING



H21049	17,2x7,1mm	2000mm	 
<b>Extra</b>			
H21053		EC 2	
H21054		MBG 2	
H21052		OD 2000mm	
H21051		TD 2000mm	

## PROFILE CURVED EMBEDDING



NE15654-8200	52,2x7,5mm / 12,3mm	2000mm	
<b>Extra</b>			
NE15679		EC	
NE22304-200		OD 2000mm	
NE22303-200		TD 2000mm	

## PROFILE SURFACE CEILING



H21048	17x7,1mm	2000mm	
<b>Extra</b>			
H21053		EC 2	
H21054		MBG 2	
H21052		OD 2000mm	
H21051		TD 2000mm	









## PROFILE SURFACE HIGH PERFORMANCE



NE15602-8200	17,8x23,2mm / 13mm	2000mm	
<b>Extra</b>			
NE15605		MBG	
NE15617		EC	
NE15611-200		TD 2000mm	
NE15612-200		OD 2000mm	
NE15614-200		30° V	
NE15615-200		60° V	

## PROFILE ALU TIBER



TLPF1414SPAN	14,5x14mm	2000mm	incl. cover, clips, endcap	
TLPF1414SPNE	14,5x14mm	2000mm	incl. cover, clips, endcap	
TLPF1414SPBL	14,5x14mm	2000mm	incl. cover, clips, endcap	
TLPF1714SPAN	17x14mm	2000mm	incl. cover, clips, endcap	
TLPF1714SPNE	17x14mm	2000mm	incl. cover, clips, endcap	
TLPF1714SPBL	17x14mm	2000mm	incl. cover, clips, endcap	
TLPF3525SPAN	35x25mm	2000mm	incl. cover, clips, endcap	
TLPF3525SPNE	35x25mm	2000mm	incl. cover, clips, endcap	
TLPF3525SPBL	35x25mm	2000mm	incl. cover, clips, endcap	

## PROFILE WALL UP/DOWN



NE22014-8200	31,7x92mm / 17,9mm	2000mm	
<b>Extra</b>			
NE22537		EC	
NE22311-200		OD 2000mm	

## PROFILE ASYMMETRIC WALL



NE15652-8200	25x52,5mm / 14,2mm	2000mm	
<b>Extra</b>			
NE15681		EC	
NE22304-200		OD 2000mm	
NE22303-200		TD 2000mm	

## PROFILE MAGNETIC



NE22003-0200	17,5x11mm / 12,3mm	2000mm	
NE22003-1200		2000mm	
NE22003-8200		2000mm	
<b>Extra</b>			
NE22303-200		TD 2000mm	
NE22304-200		OD 2000mm	
NE22312-200		ZD 2000mm	
NE22507		EC	
NE22508		BCL	
NE22509		MPC	

## PROFILE 45°



NE22004-8200	20x20mm / 15,1mm	2000mm	
<b>Extra</b>			
NE22305-200		TD 2000mm	
NE22306-200		OD 2000mm	
NE22511		EC	
NE22512		BCL	

## PLATE FOR CURVED DIFFUSER

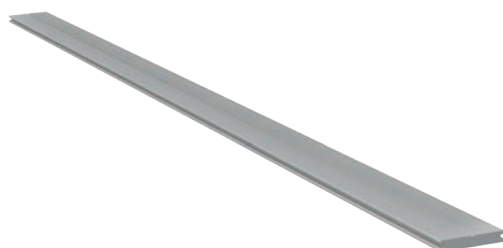

NE22005-8200	10,2x1,8mm / 10,2mm	2000mm	
<b>Extra</b>			
NE22307-200		TD 2000mm	
NE22308-200		OD 2000mm	
NE22514		EC	

## PROFILE LOW RECESSED



NE22007-0200	17,5x7,9mm / 12,3mm	2000mm	
NE22007-1200		2000mm	
NE22007-8200		2000mm	
<b>Extra</b>			
NE22303-200		TD 2000mm	
NE22304-200		OD 2000mm	
NE22312-200		ZD 2000mm	
NE22526		EC	

## PROFILE LOW SURFACE



22006-0200	17,5x7,9mm / 12,3mm	2000mm	
22006-1200		2000mm	
22006-8200		2000mm	
<b>Extra</b>			
22303-200		TD 2000mm	
22304-200		OD 2000mm	
22312-200		ZD 2000mm	
22516-1		EC	
22522-1		EC	
22310-200		30° L	
22524-1		EC	
22517		BCL	
22518		MBG	
22519		MBG 90°	
22520		VB	

## PROFILE ALU 35MM



15850-0200	35,5x45,5mm / 25mm	2000mm	
15850-1200		2000mm	
15841-200		OD 2000mm	
15852		EC	
15854		BCL	
15845		MCL	
15840-0200	35,5x35,5mm / 25mm	2000mm	
15840-1200		2000mm	
15841-200		OD 2000mm	
15842		EC	
15843		OST	
15844		BCL	
15845		MCL	

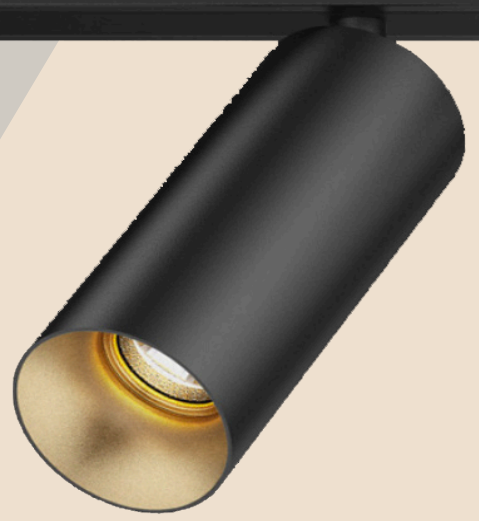

# RAILS





## 3F RAILS



A





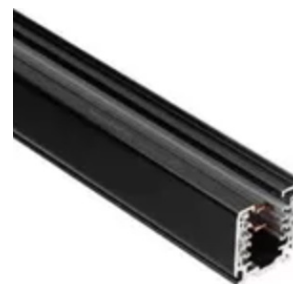





B



C



XTS100-2		A	1000mm	31,5mm x 32,5mm	
XTS200-2		A	2000mm		
XTS300-2		A	3000mm		
XTSF100-2		B	1000mm	56mm x 32,5mm	
XTSF200-2		B	2000mm		
XTSF300-2		B	3000mm		
XTSC100-2	Dali	C	1000mm	31,5mm x 32,55mm	
XTSC200-2	Dali	C	2000mm		
XTSC300-2	Dali	C	3000mm		

# 3F CONNECTOR

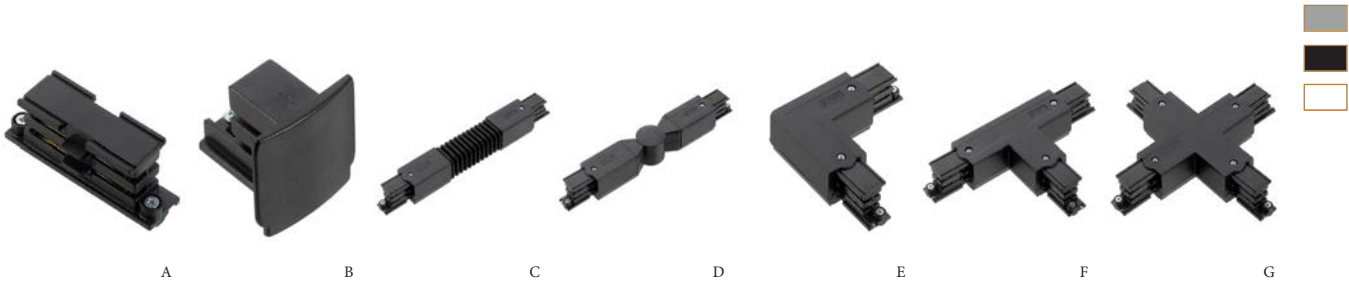













XTS21-2		A	
XTS41-2		B	
XTS23-2		C	
XTS24-2		D	
XTS34-2		E	
XTS35-2		E	
XTS36-2		F	
XTS37-2		F	
XTS39-2		F	
XTS40-2		F	
XTS38-2		G	
XTSC21-2	Dali	A	
XTSC23-2	Dali	C	
XTSC34-2	Dali	E	
XTSC35-2	Dali	E	
XTSC36-2	Dali	F	
XTSC37-2	Dali	F	
XTSC39-2	Dali	F	
XTSC40-2	Dali	F	
XTSC41-2	Dali	B	

# 3F FEEDER















XTS11-2		A	
XTS12-2		B	
XTS14-2		C	
XTSC11-2	Dali	A	
XTSC14-2	Dali	C	

## 3F SUSPENSION

						
A	B	C	D	E	F	
SKB11-T-2			A	1000mm		
VELTR1-25			B	1000mm		
VELTR2-25			B	2000mm		
VELTR4-25			B	4000mm		
VELTR1SD24-25			C	1000mm		
VELTR2SD24-25			C	2000mm		
VELTR4SD24-25			C	4000mm		
HQ.123			D			
HQ.124			E			
VELDWLS12			F	6x2000mm		
VELDWLS14			F	6x4000mm		

## 3F BRACKETS

						
A	B	C	D	E	F	
SKB12-2			A			
SKB18-2			B			
SKB16-2			C			
SKB21-2			D			
SKB11T-2			E			
SKB11WLLZ-2			F			

## 3F SURFACE MOUNTED BASE TRACK ADAPTER

		
L26361903	183x70mm H 33mm	
L26363901	183x70mm H 33mm	



## BCN50 TRACK



		O/F - PC - Dali		Incl.
		65.000h L80 B10		5
		20° - 40° - 60°		>90
		IP 20		DTW 1800/3000K 2700K - 3000K - 4000K
		55mm H 130mm		

NE06505-2E20	6W	20°	760 lm	930	
NE06505-2E21	9W	20°	1030 lm	930	
NE06505-2E22	13W	20°	1330 lm	930	

## BCN90 TRACK



		O/F - Dali - BT		Incl.
		65.000h L80 B10		5
		15° - 36° - 60°		>90
		IP 20		2700K - 3000K - 4000K B - M - F - V - R
		90mm H 202mm		

NE06513-2E62	12W	60°	1900 lm	930	
NE06513-2E63	18W	60°	2600 lm	930	
NE06513-2E64	25W	60°	3600 lm	930	
NE06513-2E65	33W	60°	4400 lm	930	

## BCN120 TRACK



		O/F - Dali - BT		Incl.
		65.000h L80 B10		5
		15° - 36° - 60°		>90
		IP 20		2700K - 3000K - 4000K B - M - F - V - R
		120mm H 252mm		

NE06533-2E62	12W	60°	1950 lm	930	
NE06533-2E63	18W	60°	2700 lm	930	
NE06533-2E64	25W	60°	3700 lm	930	
NE06533-2E65	33W	60°	4500 lm	930	
NE06533-2E66	35W	60°	5800 lm	930	
NE06533-2E67	42W	60°	6300 lm	930	

## OWWL ZOOM



		MAN		Incl.
		50.000h L80 B10		3
		24 - 60°		>90
		IP 20		CCT 2700K/3000K/4000K
		80 mm H 170mm		

NE26111-OSZ4M	35W	24-60°	3675 lm	9~	
NE26110-OSZ3M	20W	24-60°	1930 lm	9~	

## TOKYO



		MAN		Incl.
		50.000h L80 B10		3
		15 - 55°		>90
		IP 20		CCT 2700K/3000K/4000K
		~mm H ~mm		

HOF150052218	70mm H 160mm	15W	15-55°	1080/1115/1200 lm	9~	
HOF150062218	85mm H165mm	30W	15-55°	1955/2025/2175 lm	9~	

## SUTIL MINI TR



		O/F - Dali		Incl.
		30.000h		3
		30° - 40° - 55°		>90
		IP 20		CCT 2700K/3000K/4000K
		45mm H 130mm		

NE26035-0S30	8W	30°	790 lm	9~	
NE26035-1S40	8W	40°	790 lm	9~	
NE26035-1S50	8W	55°	790 lm	9~	

## SUTIL MINI PRO TR



		O/F - Dali		Incl.
		50.000h		5
		30° - 40° - 55°		>90
		IP 20		2700K - 3000K - 4000K
		45mm H 130mm		

NE26036-0H33	20W	30°	2548 lm	927	
NE26036-1E43	20W	40°	2548 lm	930	
NE26036-1F53	20W	55°	2548 lm	940	

## EYE



		O/F - Dali - BT		Incl.
		65.000h L80 B10		5
		15° - 36°		>90
		IP 20		2700K - 3000K - 3500K - 4000K
		~mm H ~mm		

NE06101-1E32	86mm H 99mm	12,5W	36°	1500 lm	930	
NE06102-1E32	100mm H 113mm	12,5W	36°	1500 lm	930	
NE06102-1E33		18W	36°	2000 lm	930	
NE06103-1E33	120mm H 132mm	18W	36°	2000 lm	930	
NE06103-1E34		26W	36°	3000 lm	930	

## VALI



LUVALI32930GOBOW

<input type="checkbox"/>		Dali - CAS		Incl.
<input type="checkbox"/>		100.000h L80 B10		5
		25 - 35°		>90
		IP 20		3000K - 4000K
		86mm H 310mm		
		32W	25-35°	1000 lm
				930
				<input type="checkbox"/>

## FULGOR



MC41666

MC41667

MC41668

MC41669

<input type="checkbox"/>		O/F - Dali		Incl.
<input type="checkbox"/>		50.000h L90 B10		5
		15° - 24° - 38° - 55°		>90
		IP 20		3000K - 4000K
		69mm H 140mm		
		24W	55°	2300 lm
				930
				<input type="checkbox"/>
				<input type="checkbox"/>
				<input type="checkbox"/>
				<input type="checkbox"/>

## UNICO DICRO GU10



H40758

H40759

<input type="checkbox"/>				
<input type="checkbox"/>				5
		IP 20		
		68mm H 92mm		
				<input type="checkbox"/>
				<input type="checkbox"/>

## BOGOTA 3F GU10



HOF151901190

HOF151901290

<input type="checkbox"/>				
<input type="checkbox"/>				3
		IP 20		
		68mm H 100mm		
				<input type="checkbox"/>
				<input type="checkbox"/>



## TR ED



	O/F - CAS - Dali	Incl.
	100.000h L80 B10	5
	15° - 25° - 40° - 45° - 60°	>90 - 98 - 97
	IP 20	3000K - 4000K - B - M - F - V - R
	~mm H ~mm	

LUTREDS119340W	85mm H 104mm	11W	40°	1600 lm	930	
LUTREDS149340W		14W	40°	1950 lm	930	
LUTREDS193040W	95mm H 112mm	19W	45°	2650 lm	930	
LUTREDM239340W		23W	45°	3150 lm	930	
LUTREDM319340W		31W	45°	3950 lm	930	
LUTREDL319340W	106mm H 123mm	31W	40°	4150 lm	930	
LUTREDL409340W		40W	40°	5450 lm	930	

## TR WED



	1-10V - PC - Dali - CAS	Incl.
	100.000h L80 B10	5
	15° - 25° - 40° - 65°	>90 >98
	IP 20	2700K-3000K - 3500K - 4000K - V - M - F - B - R
	~mm H ~mm	

LUTRWED119340B		11W	40°	1750 lm	930	
LUTRWED149340B		14W	40°	2150 lm	930	
LUTRWED199340B		19W	40°	2850 lm	930	
LUTRWED239340B		23W	40°	3350 lm	930	
LUTRWED23MEAT40B		23W	40°	1800 lm	CRI98	
LUTRWED23FISH40B		23W	40°	2100 lm	CRI98	
LUTRWED23BREAD40B		23W	40°	1900 lm	CRI98	
LUTRWED23RETAIL40B		23W	40°	2300 lm	CRI98	

## SKA TR



	O/F - 1-10V - CAS - Dali	Incl.
	100.000h L80 B10	5
	15° - 25° - 45° - 60°	>90 - 98 - 97
	IP 20	CCT 2700K/6500K - 3000K - 4000K - B - M - F - V - R
	~mm H ~mm	

LUTRSKA99345W	160mm H 180mm	9,5W	45°	1450 lm	930	
LUTRSKA149345W		14W	45°	2150 lm	930	
LUTRSKA199345W		19W	45°	2750 lm	930	



## AI SPOT



		AUT.		Incl.
		50.000 L70 B10		5
		24°		>90
		IP 20		CCT 2700K/6500K
		90mm H 160mm		

HA20203400101	35W	24°	9~	
HA20203400103	35W	24°	9~	

## NAN TR



		O/F - 1-10V - PC - CAS - Dali		Incl.
		100.000h L80 B10		5
		90x60° - 90x70°		>80 - >90 - 98 - 97
		IP 20		CCT 1800K/3000K - 3000K - 4000K - B - M - F - V - R
		~mm H ~mm		

LUTRNANS993W	136x94mm H 152mm	9,5W	90x60°	1100 lm	930	
LUTRNANS1893W		18W	90x60°	2100 lm	930	
LUTRNANS3093W		30W	90x60°	3150 lm	930	
LUTRNANL3893W	180x115mm H 164mm	38,5W	90x60°	4350 lm	930	

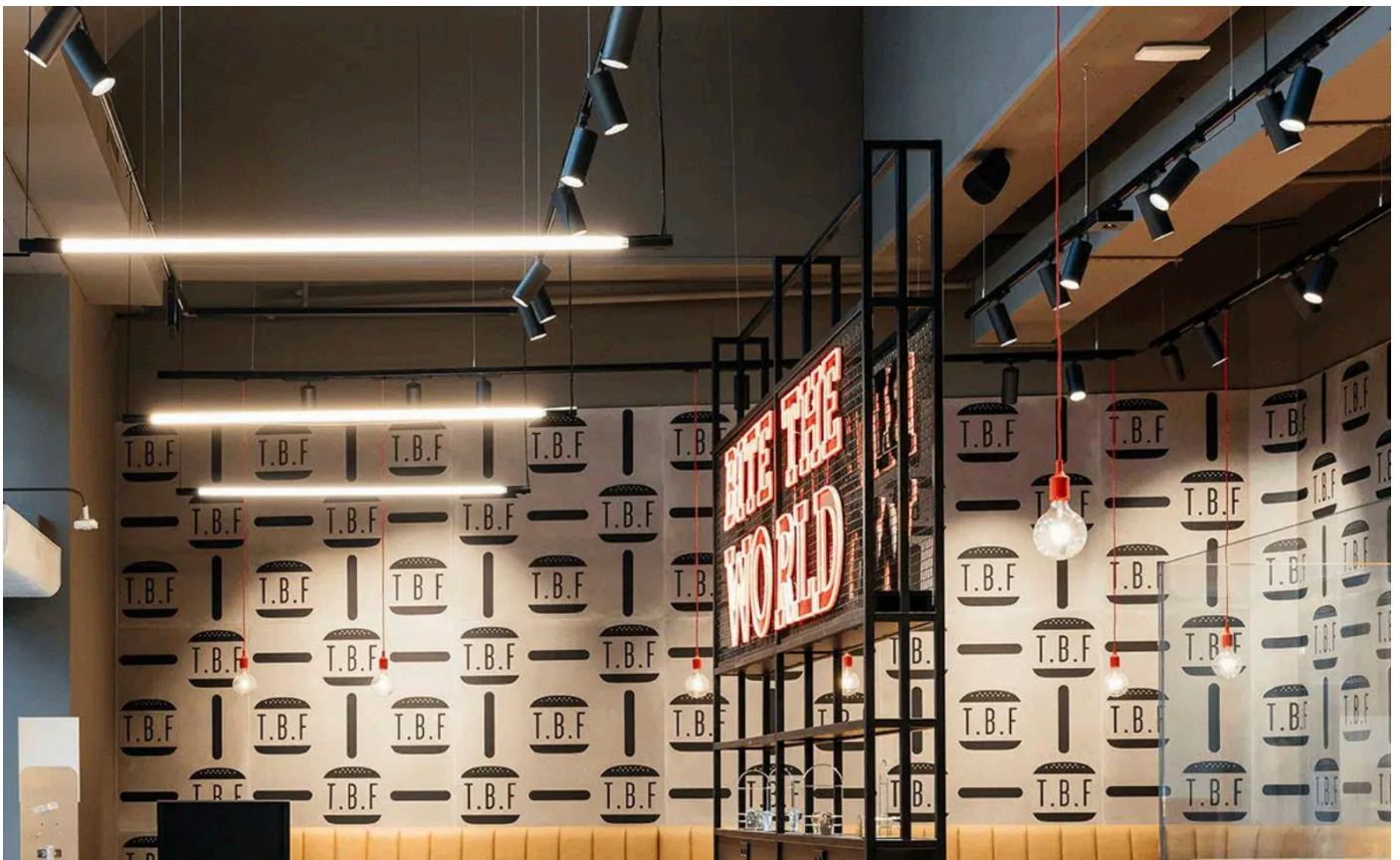

## SLIDE SYMMETRIC



		O/F		Incl.
		65.000h L80 B10		5
		12° - 20° - 30° - 60°		>80
		IP 20		3000K - 4000K
		152x30mm H 149mm		

NE06301-OC31

15W 30° 1300 lm 830



NE06301-1C31

15W 30° 1300 lm 830



## SLIDE WALLWASH



		O/F		Incl.
		65.000h L80 B10		5
		100°		>90
		IP 20		3000K - 4000K
		152x30mm H 106mm		

NE06312-OC91

15W 100° 2650 lm 930



NE06312-1C91

15W 100° 2650 lm 930



## BRAG



		O/F - Dali - CAS - 1-10V		Incl.
		100.000h L80 B10		5
		65° x 45°		>90
		IP 20		2700K - 3000K - 3500K - 4000K
		~mm H ~mm		

LUTRBRAG1193W

11W 65° x 45° 1750 lm 930



LUTRBRAG1493W

14W 65° x 45° 2000 lm 930



LUTRBRAG1993W

19W 65° x 45° 2800 lm 930



LUTRBRAG2393W

23W 65° x 45° 3250 lm 930



LUTRBRAG3193W

31W 65° x 45° 4200 lm 930



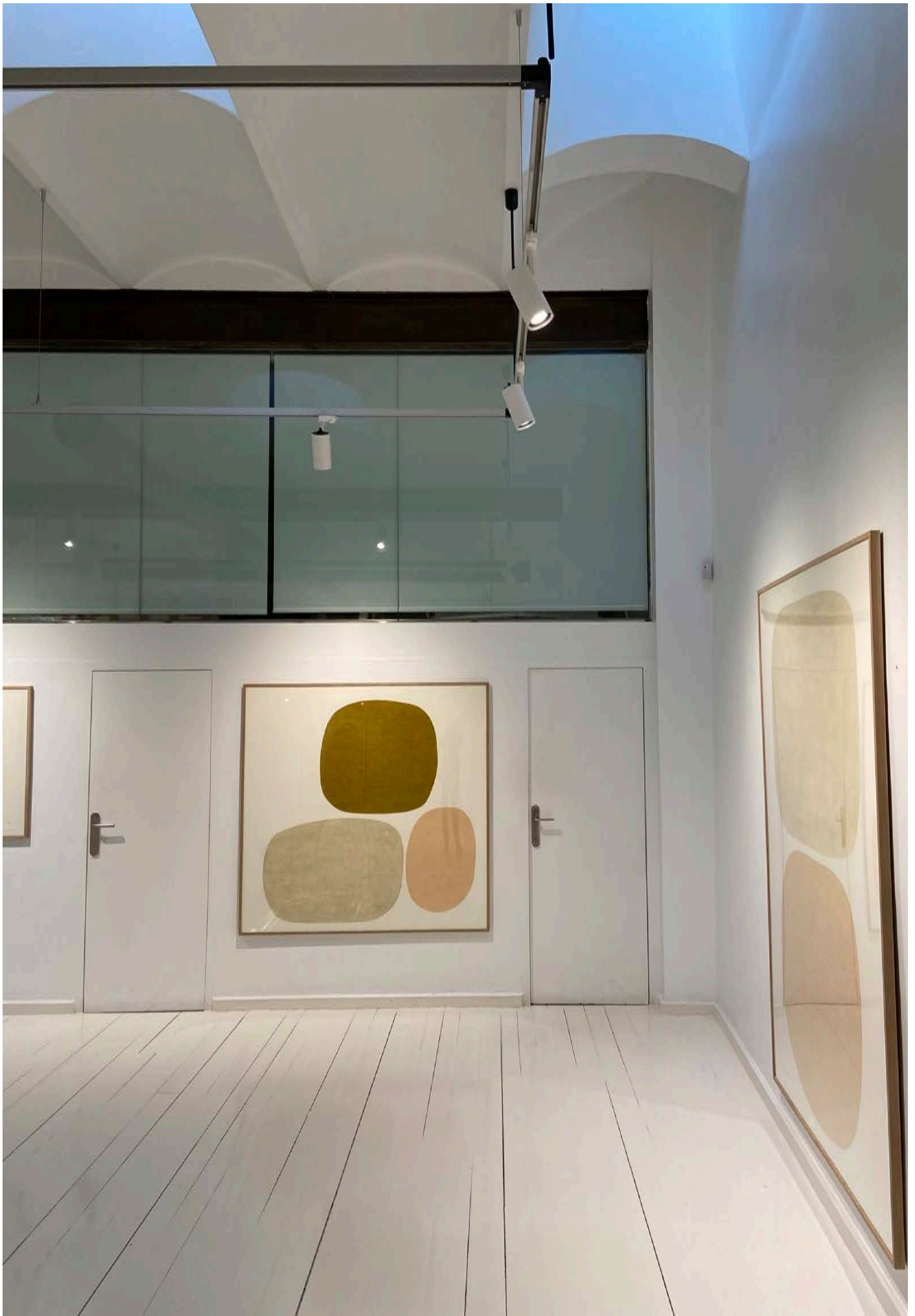

## IR TR OPAL



		O/F - CAS - Dali		Incl.
		100.000h L80 B10		5
		DA - 30° - 55° - 90° - 105° - 32°x72°		>90
		IP 20		2700K - 3000K - 4000K
		44x853mm H 39mm		

LUTRIR4093OPW

40W 110° 4400 lm 930

## IR TR LOUVRE



		O/F -Dali - CAS		Incl.
		100.000h L80 B10		5
		110°		>90
		IP 20		2700K - 3000K - 4000K
		44x853mm H 27mm		

LUTRIR4293LOUVREW80W

42W 80° 3800 lm 930

LUTRIR4293LOUVREB80B

42W 80° 3800 lm 930

## FORS



		O/F -Dali		Incl.
				5
		30° - 60° - 90° - DA - AS		>90
		IP 20		3000K - 4000K
		66x865mm H 55mm		

LUTRFORS369390B

36W 60° 5450 lm 930

LUTRFORS369360B

36W 90° 5450 lm 930

LUTRFORS3693DAB

36W DA 5450 lm 930

LUTRFORS3693ASB

36W AS 5450 lm 930

LUTRFORS529390B

52W 90° 7350 lm 930

LUTRFORS529360B

52W 60° 7350 lm 930

LUTRFORS5293DAB













52W DA 7350 lm 930

LUTRFORS5293ASB

52W AS 7350 lm 930

## NEW LINJE















		O/F - Dali		Incl.
		65.000h L80 B10		5
		60° - 90° - DA		>80
		IP 20		3000K - 4000K
		62x1493mm H 11,2mm		





NE23510-0C69	35 - 50W	60°	8000 lm	830	
NE23510-1N99	35 - 50W	90°	8000 lm	840	



## SHOP FLAT



		O/F - Dali		Incl.
		50.000h L80 B10		5
		90° - AS		>80
		IP 20		3000K - 4000K
		64x~mm H 20mm		

LDFLATL5083WBB	880mm	50W	90°	7500 lm	830	
LDFLATL5083ASB		50W	AS	7500 lm	830	
LDFLATM4083WBB	587mm	40W	90°	6000 lm	830	
LDFLATM4083ASB		40W	AS	6000 lm	830	



LIJN  
LIGNE





BAB51124F4	CB 1/1124mm	5x2,5mm	1 U - 1124mm	
BAB52248F4		5x2,5mm	2 U - 2248mm	
BAB53372F4		5x2,5mm	3 U - 3372mm	
BAB71124F4		7x2,5mm	1 U - 1124mm	
BAB72248F4		7x2,5mm	2 U - 2248mm	
BAB73372F4		7x2,5mm	3 U - 3372mm	
BAB91124F4		9x2,5mm	1 U - 1124mm	
BAB92248F4		9x2,5mm	2 U - 2248mm	
BAB93372F4		9x2,5mm	3 U - 3372mm	
BAB111124F4		11x2,5mm	1 U - 1124mm	
BAB112248F4		11x2,5mm	2 U - 2248mm	
BAB113372F4		11x2,5mm	3 U - 3372mm	
BAB51686F6	CB 1/1686mm	5x2,5mm	1 U - 1686mm	
BAB53372F6		5x2,5mm	2 U - 3372mm	
BAB71686F6		7x2,5mm	1 U - 1686mm	
BAB73372F6		7x2,5mm	2 U - 3372mm	
BAB91686F6		9x2,5mm	1 U - 1686mm	
BAB93372F6		9x2,5mm	2 U - 3372mm	
BAB111686F6		11x2,5mm	1 U - 1686mm	
BAB113372F6		11x2,5mm	2 U - 3372mm	
BAB52248F8	CB 1/2248mm	5x2,5mm	1 U - 2246mm	
BAB72248F8		7x2,5mm	1 U - 2246mm	
BAB92248F8		9x2,5mm	1 U - 2246mm	
BAB112248F8		11x2,5mm	1 U - 2246mm	

# QRAILX MODULE 4FT



		O/F - Dali		Incl.
		100.000h L80 B10		5
		UNB - NB - MB - WB - UWB - DA - AS - O - ODI		>80 - >90
		IP 40		3000K - 4000K - 6500K
		1124mm		

BAB324F84UNB	17,7W	UNB	3200 lm	840	
BAB404F84UNB	22,2W	UNB	4000 lm	840	
BAB604F84UNB	33,3W	UNB	6000 lm	840	
BAB804F84UNB	44,4W	UNB	8000 lm	840	
BAB804F84UNBE		UNB	NOOD	840	
BAB324F84NB	17,7W	NB	3200 lm	840	
BAB404F84NB	22,2W	NB	4000 lm	840	
BAB604F84NB	33,3W	NB	6000 lm	840	
BAB804F84NB	44,4W	NB	8000 lm	840	
BAB404F84NBE		NB	NOOD	840	
BAB324F84MB	17,7W	MB	3200 lm	840	
BAB404F84MB	22,2W	MB	4000 lm	840	
BAB604F84MB	33,3W	MB	6000 lm	840	
BAB804F84MB	44,4W	MB	8000 lm	840	
BAB804F84MBE		MB	NOOD	840	
BAB324F84WB	17,7W	WB	3200 lm	840	
BAB404F84WB	22,2W	WB	4000 lm	840	
BAB604F84WB	33,3W	WB	6000 lm	840	
BAB804F84WB	44,4W	WB	8000 lm	840	
BAB804F84WBE		WB	NOOD	840	



BAB324F84UWB	17,7W	UWB	3200 lm	840	■
BAB404F84UWB	22,2W	UWB	4000 lm	840	■
BAB604F84UWB	33,3W	UWB	6000 lm	840	■
BAB804F84UWB	44,4W	UWB	8000 lm	840	■
BAB804F84UWBE		UWB	NOOD	840	■
BAB324F84DA	17,7W	DA	3200 lm	840	■
BAB404F84DA	22,2W	DA	4000 lm	840	■
BAB604F84DA	33,3W	DA	6000 lm	840	■
BAB804F84DA	44,4W	DA	8000 lm	840	■
BAB804F84DAE		DA	NOOD	840	■
BAB324F84AS	17,7W	AS	3200 lm	840	■
BAB404F84AS	22,2W	AS	4000 lm	840	■
BAB604F84AS	33,3W	AS	6000 lm	840	■
BAB804F84AS	44,4W	AS	8000 lm	840	■
BAB804F84ASE		AS	NOOD	840	■
BAB324F84O	17,7W	O	3200 lm	840	■
BAB404F84O	22,2W	O	4000 lm	840	■
BAB604F84O	33,3W	O	6000 lm	840	■
BAB804F84O	44,4W	O	8000 lm	840	■
BAB804F84OE		O	NOOD	840	■
BAB324F84ODI	17,7W	ODI	3200 lm	840	■
BAB404F84ODI	22,2W	ODI	4000 lm	840	■
BAB604F84ODI	33,3W	ODI	6000 lm	840	■
BAB804F84ODI	44,4W	ODI	8000 lm	840	■
BAB804F84ODIE		ODI	NOOD	840	■

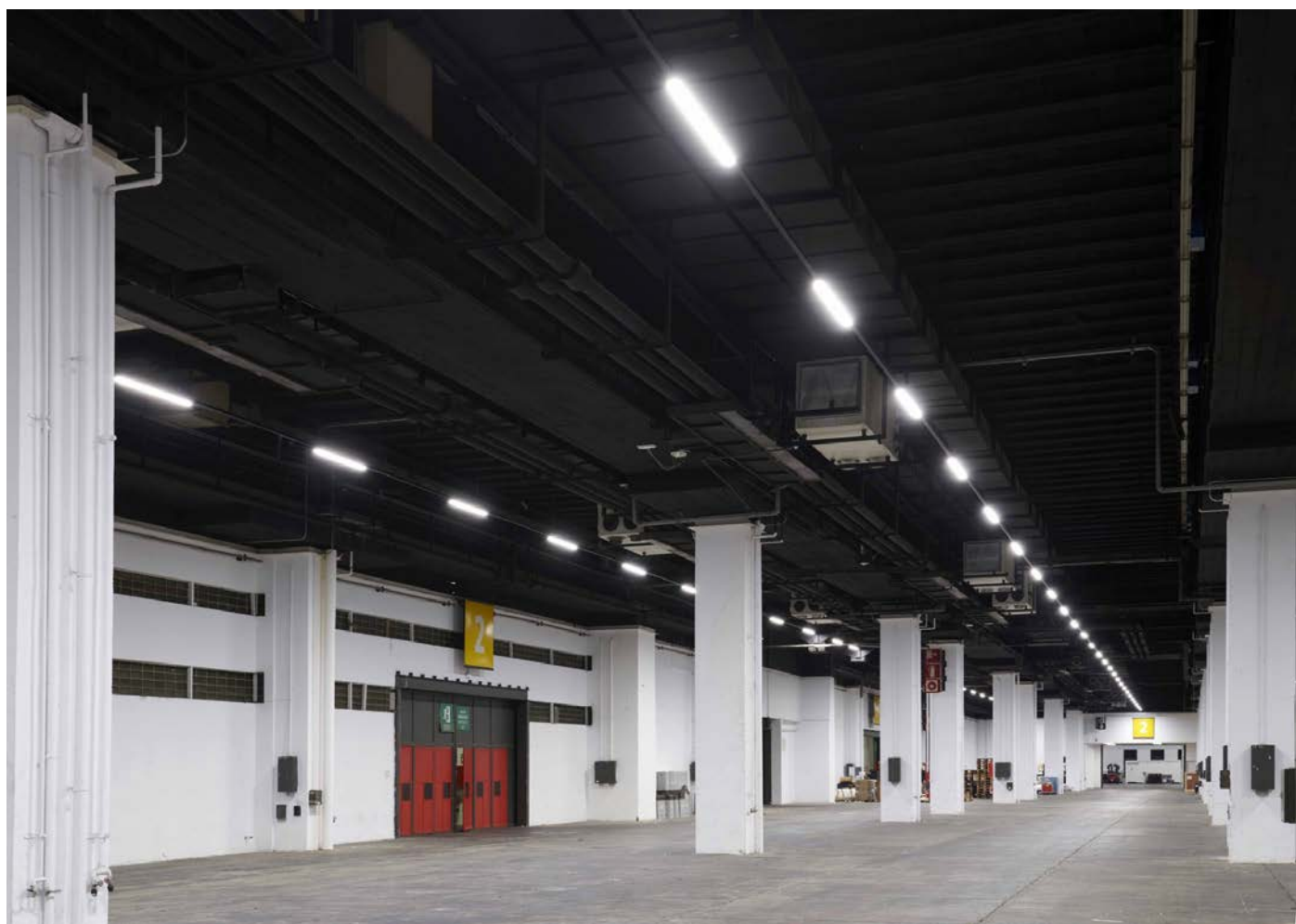

# QRAILX MODULE 6FT



		O/F - Dali		Incl.
		100.000h L80 B10		5
		UNB - NB - MB - WB - UWB - DA - AS - O - ODI		>80 - >90
		IP 40		3000K - 4000K - 6500K
		1686mm		

BAB486F84UNB	26,6W	UNB	4800 lm	840	
BAB606F84UNB	33,3W	UNB	6000 lm	840	
BAB906F84UNB	50W	UNB	9000 lm	840	
BAB1206F84UNB	66,6W	UNB	12000 lm	840	
BAB1206F84UNBE		UNB	NOOD	840	
BAB486F84NB	26,6W	NB	4800 lm	840	
BAB606F84NB	33,3W	NB	6000 lm	840	
BAB906F84NB	50W	NB	9000 lm	840	
BAB1206F84NB	66,6W	NB	12000 lm	840	
BAB1606F84NB	88,8W	NB	16000 lm	840	
BAB1606F84NBE		NB	NOOD	840	
BAB486F84MB	26,6W	MB	4800 lm	840	
BAB606F84MB	33,3W	MB	6000 lm	840	
BAB906F84MB	50W	MB	9000 lm	840	
BAB1206F84MB	66,6W	MB	12000 lm	840	
BAB1606F84MB	88,8W	MB	16000 lm	840	
BAB1606F84MBE		MB	NOOD	840	
BAB486F84WB	26,6W	WB	4800 lm	840	
BAB606F84WB	33,3W	WB	6000 lm	840	
BAB906F84WB	50W	WB	9000 lm	840	
BAB1206F84WB	66,6W	WB	12000 lm	840	
BAB1606F84WB	88,8W	WB	16000 lm	840	
BAB1606F84WBE		WB	NOOD	840	
BAB486F84UWB	26,6W	UWB	4800 lm	840	
BAB606F84UWB	33,3W	UWB	6000 lm	840	
BAB906F84UWB	50W	UWB	9000 lm	840	
BAB1206F84UWB	66,6W	UWB	12000 lm	840	
BAB1606F84UWB	88,8W	UWB	16000 lm	840	
BAB1606F84UWBE		UWB	NOOD	840	

BAB486F84DA	26,6W	DA	4800 lm	840	■
BAB606F84DA	33,3W	DA	6000 lm	840	■
BAB906F84DA	50W	DA	9000 lm	840	■
BAB1206F84DA	66,6W	DA	12 000 lm	840	■
BAB1606F84DA	88,8W	DA	16 000 lm	840	■
BAB1606F84DAE		DA	NOOD	840	■
BAB486F84AS	26,6W	AS	4800 lm	840	■
BAB606F84AS	33,3W	AS	6000 lm	840	■
BAB906F84AS	50W	AS	9000 lm	840	■
BAB1206F84AS	66,6W	AS	12000 lm	840	■
BAB1606F84AS	88,8W	AS	16000 lm	840	■
BAB1606F84ASE		AS	NOOD	840	■
BAB486F84O	26,6W	O	4800 lm	840	■
BAB606F84O	33,3W	O	6000 lm	840	■
BAB906F84O	50W	O	9000 lm	840	■
BAB1206F84O	66,6W	O	12000 lm	840	■
BAB1606F84O	88,8W	O	16000 lm	840	■
BAB1606F84OE		O	NOOD	840	■
BAB486F84ODI	26,6W	ODI	4800 lm	840	■
BAB606F84ODI	33,3W	ODI	6000 lm	840	■
BAB906F84ODI	50W	ODI	9000 lm	840	■
BAB1206F84ODI	66,6W	ODI	12000 lm	840	■
BAB1606F84ODI	88,8W	ODI	16000 lm	840	■
BAB1606F84ODIE		ODI	NOOD	840	■



# QRAILX MODULE 8FT



		0/F - Dali		Incl.
		100.000h L80 B10		5
		UNB - NB - MB - WB - UWB - DA - AS - O - ODI		>80 - >90
		IP 40		3000K - 4000K - 6500K
		2248mm		

BAB648F84UNB	35,5W	UNB	6400 lm	840	
BAB808F84UNB	44,4W	UNB	8000 lm	840	
BAB1208F84 UNB	66,6W	UNB	12000 lm	840	
BAB1608F84UNB	88,8W	UNB	16000 lm	840	
BAB2108F84UNB	116,6W	UNB	21000 lm	840	
BAB2108F84UNBE		UNB	NOOD	840	
BAB648F84NB	35,5W	NB	6400 lm	840	
BAB808F84NB	44,4W	NB	8000 lm	840	
BAB1208F84NB	66,6W	NB	12000 lm	840	
BAB1608F84NB	88,8W	NB	16000 lm	840	
BAB2108F84NB	116,6W	NB	21000 lm	840	
BAB2108F84NBE		NB	NOOD	840	
BAB648F84MB	35,5W	MB	6400 lm	840	
BAB808F84MB	44,4W	MB	8000 lm	840	
BAB1208F84MB	66,6W	MB	12000 lm	840	
BAB1608F84MB	88,8W	MB	16000 lm	840	
BAB2108F84MB	116,6W	MB	21000 lm	840	
BAB2108F84MBE		MB	NOOD	840	
BAB648F84WB	35,5W	WB	6400 lm	840	
BAB808F84WB	44,4W	WB	8000 lm	840	
BAB1208F84WB	66,6W	WB	12000 lm	840	
BAB1608F84WB	88,8W	WB	16000 lm	840	
BAB2108F84WB	116,6W	WB	21000 lm	840	
BAB2108F84WBE		WB	NOOD	840	
BAB648F84UWB	35,5W	UWB	6400 lm	840	
BAB808F84UWB	44,4W	UWB	8000 lm	840	
BAB1208F84UWB	66,6W	UWB	12000 lm	840	
BAB1608F84UWB	88,8W	UWB	16000 lm	840	
BAB2108F84UWB	116,6W	UWB	21000 lm	840	
BAB2108F84UWBE		UWB	NOOD	840	

BAB648F84DA	35,5W	DA	6400 lm	840	■
BAB808F84DA	44,4W	DA	8000 lm	840	■
BAB1208F84DA	66,6W	DA	12000 lm	840	■
BAB1608F84DA	88,8W	DA	16000 lm	840	■
BAB2108F84DA	116,6W	DA	21000 lm	840	■
BAB2108F84DAE		DA	NOOD	840	■
BAB648F84AS	35,5W	AS	6400 lm	840	■
BAB808F84AS	44,4W	AS	8000 lm	840	■
BAB1208F84AS	66,6W	AS	12000 lm	840	■
BAB1608F84AS	88,8W	AS	16000 lm	840	■
BAB2108F84AS	116,6W	AS	21000 lm	840	■
BAB2108F84ASE		AS	NOOD	840	■
BAB648F84O	35,5W	O	6400 lm	840	■
BAB808F84O	44,4W	O	8000 lm	840	■
BAB1208F84O	66,6W	O	12000 lm	840	■
BAB1608F84O	88,8W	O	16000 lm	840	■
BAB2108F84O	116,6W	O	21000 lm	840	■
BAB2108F84OE		O	NOOD	840	■
BAB648F84ODI	35,5W	ODI	6400 lm	840	■
BAB808F84ODI	44,4W	ODI	8000 lm	840	■
BAB1208F84ODI	66,6W	ODI	12000 lm	840	■
BAB1608F84ODI	88,8W	ODI	16000 lm	840	■
BAB2108F84ODI	116,6W	ODI	21000 lm	840	■
BAB2108F84ODIE		ODI	NOOD	840	■

## SKADI ECO SPOT



		O/F		Incl.
		50.000h L80 B10		5
		NB - MB - WB		>80 - >90
		IP 20		3000K - 4000K
		100mm H 198mm		

LUBABSKECO28930NB	28W	NB	2300 lm	930	■
LUBABSKECO56930NB	56W	NB	2x2300 lm	930	■
LUBABSKECO28840NB	28W	NB	2800 lm	840	■
LUBABSKECO56840NB	56W	NB	2x2800 lm	840	■
LUBABSKECO34930WB	28W	WB	3200 lm	930	■
LUBABSKECO69930WB	56W	WB	2x3200 lm	930	■
LUBABSKECO26840WB	26W	WB	3200 lm	840	■
LUBABSKECO69840WB	52W	WB	2x3200 lm	840	■



## QRAILX 3F TRACK



BAW0562T	562mm	
BAB0562T	562mm	
BAG0562T	562mm	
BAW1124T	1124mm	
BAB1124T	1124mm	
BAG1124T	1124mm	

## QRAILX TRUNK SENSOR

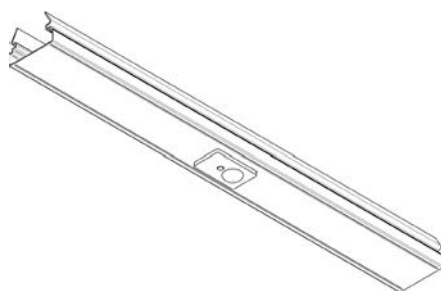

BABSTIS3360M2F	562mm	360° S	4m	
BABSTIS3360XM2F	562mm	360° S	14m	
BABSTIS345M2F	562mm	LIJN S	4m	
BABSTIS345XM2F	562mm	LIJN S	14m	

## QRAILX BLIND COVER

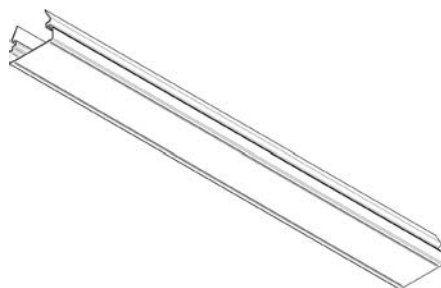

BAB0280BC	280mm	
BAB0560BC	560mm	
BAB1124BC	1124mm	
BAB1686BC	1686mm	

## QRAILX CONNECTOR

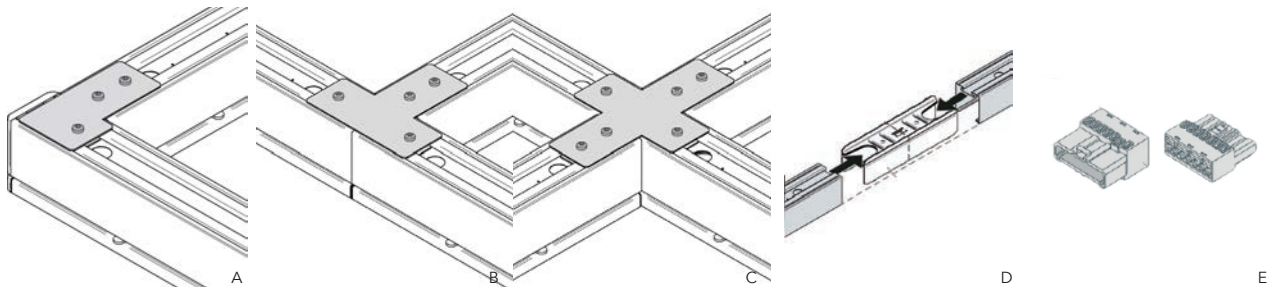

BALCO	A
BATCO	B
BAXCO	C
BACP	D
BAPLUG	E

## QRAILX BRACKETS



BAXMBRT	A
BAXMBSFM	B
BAXMBTPR	C
BAXMBSWA	D
BAXMBE	E

## QRAILX END CAP



BAWEPSET	
BABEPSET	
BAGEPSET	
BAWEPSETODI	
BABEPSETODI	
BAGEPSETODI	
BAWEPSET911	
BABEPSET911	
BAGEPSET911	



## EASY FIT MODULE



	O/F - 0-10V - Dali - BT		Incl.
	100.000h L80 B20		5
	30° - 60° - 90° - 120°		>80 - >90
	IP 40		4000K - 5000K
	~mm H ~mm		

AGEF26084T5UWB	32-60W	120°	180 lm/W	840	
AGEF26084TLWB	32-60W	90°	180 lm/W	840	
AGEF26084TLMB	32-60W	60°	180 lm/W	840	
AGEF26084T5NB	32-60W	30°	180 lm/W	840	
<b>Extra</b>					
AGEF26083T5NBE	NOOD				

## INNOTRACK



	O/F - Dali		Excl.
	100.000h L80 B10		5
	32° - 80° - 160°		>80
	IP 66 / IK 08		4000K - 5000K - 6000K
	~x40mm H 60mm		

IGIT15268084	1500mm	26W	80°	4160 lm	840	
IGIT15378084		37W	80°	5840 lm	840	
IGIT15528084		52W	80°	8320 lm	840	
IGIT15648084		64W	80°	10250 lm	840	
IGIT15788084		78W	80°	12500 lm	840	
IGIT45788084	4500mm	78W	80°	12500 lm	840	
IGIT451108084		110W	80°	17500 lm	840	
IGIT451568084		156W	80°	25000 lm	840	
IGIT451928084		192W	80°	30750 lm	840	
IGIT452348084		234W	80°	37500 lm	840	

## DATALUX AC

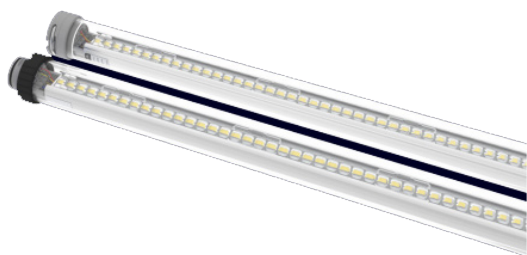

	O/F		Incl.
	100.000h L80 B10		5
	30° - 90° - 110°		>84
	IP 65 / IK 10		4000K - 5000K
	~mm H 40 mm		

WWAC2WA4005K0C	2025mm	29,8W	90°	4130 lm	840	
WWAC2WA4008K0C		45,3W	90°	5990 lm	840	
WWAC3WA4003K5C	3000mm	29,5W	90°	4170 lm	840	
WWAC3WA4005K0C		44,6W	90°	6120 lm	840	

## DATALUX LT



	O/F - 0-10V		Excl.
	100.000h L80 B10		5
	30° - 90° - 110°		>84
	IP 65 / IK 10		4000K - 5000K
	~mm H 60 mm		

WWDC2WA4002K5	2025mm	11,1W	90°	1880 lm	840	
WWDC2WA4003K5		15,7W	90°	2620 lm	840	
WWDC2WA4005K0		23W	90°	3740 lm	840	
WWDC2WA4006K5		30,5W	90°	4920 lm	840	
WWDC2WA4008K0		36,3W	90°	6070 lm	840	
WWDC2WA4012K0		49,8W	90°	8040 lm	840	
WWDC3WA4002K5	3000mm	16,7W	90°	2800 lm	840	
WWDC3WA4003K5		23,7W	90°	3920 lm	840	
WWDC3WA05K0		34,7W	90°	5590 lm	840	
WWDC3WA06K5		45,7W	90°	7300 lm	840	
WWDC3WA08K0		54W	90°	8950 lm	840	
WWDC3WA12K0		74,3W	90°	11830 lm	840	



# DATALUX NEXT GEN

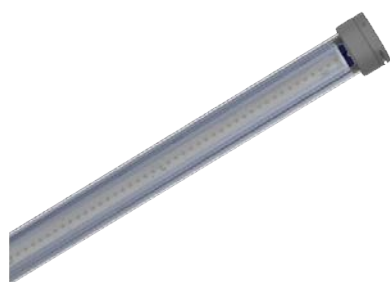

	0/F - Dali		Incl.
	100.000h L80 B10		5
	30° - 60° - 90° - 110°		>84
	IP 65 / IK 10		4000K - 5000K
	~mm H 60 mm		

WWNG2DCWB404K5	2330mm	19,4W	90°	2930 lm	840	
WWNG2DCWB406K		27,7W	90°	4200 lm	840	
WWNG2DCWB408K		35,3W	90°	5325 lm	840	
WWNG2DCWB409K5		43,1W	90°	6480 lm	840	
WWNG2DCWB4014K		64,5W	90°	9510 lm	840	
WWNG2DCWB4018K		87,1W	90°	12490 lm	840	
WWNG3DCWB404K5	3450mm	29,4W	90°	4395 lm	840	
WWNG3DCWB406K		42,3W	90°	6305 lm	840	
WWNG3DCWB408K		51,7W	90°	7985 lm	840	
WWNG3DCWB409K5		64,5W	90°	9895 lm	840	
WWNG3DCWB4014K		95,3W	90°	14265 lm	840	
WWNG3DCWB4018K		129,1W	90°	18735 lm	840	

# TS



	0/F - Dali		Incl.
	80.000h L80 B50		5
	35° - 60° - 90° - AS - OC - PM		>80
	IP 20		2700K - 3000K - 4000K - 5700K - 6500K
	53x55mm H ~mm		

MOTSM2284WB		22W		3500 lm	840	
MOTSM3984WB		39W		5600 lm	840	
MOTSM5784WB		57W		7700 lm	840	
MOTSM6584WB		65W		9700 lm	840	
MOTSA1L5	1422mm		Rail			
MOTSA2L5	2844mm		Rail			
MOTSCPS			Connection set for power entry			
MOTSCL	1422mm		Blind cover			
MOTSCZH21	2000mm		OST + cable (2pcs)			
MOTSCD			Surface mounting bracket			

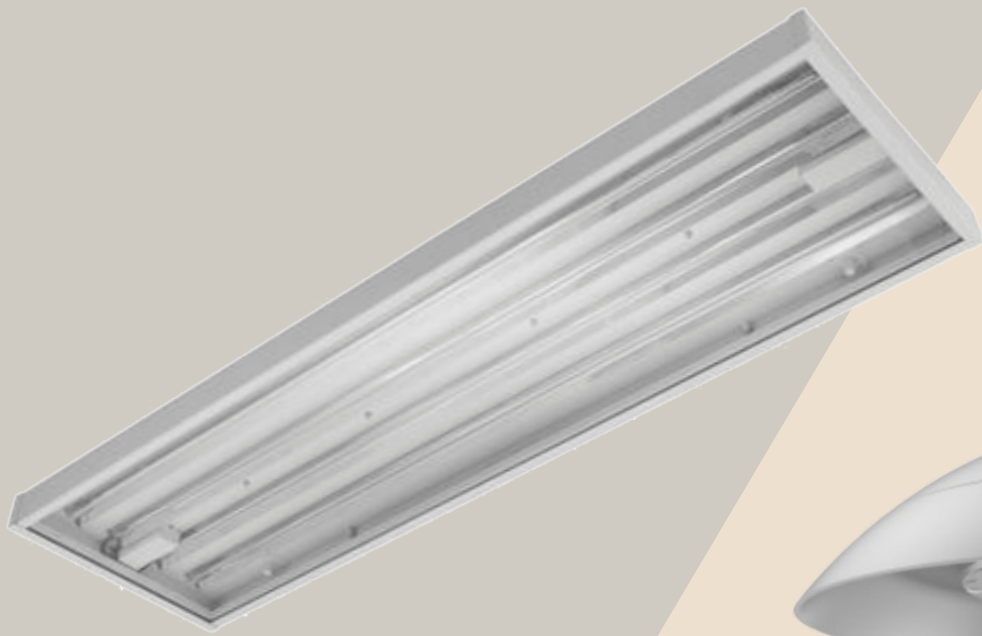

INDUSTRIE  
INDUSTRIEL



## ALIN HT

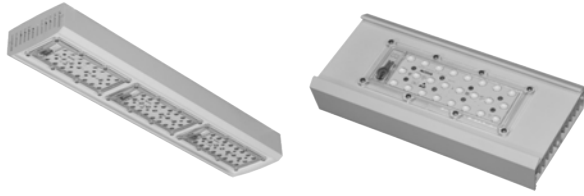

		O/F - Dali		Incl.
		80.000h L80 B50		5
		30° - 90°		>80
		IP 65		3000K - 4000K - 5700K - 6500K
		~x120mm H 90mm		

MOALIN75S4W1GHT	263mm	75W	90°	10100 lm	840	
MOALIN145M4W2GHT	653mm	145W	90°	21500 lm	840	
MOALIN224L4W3GHT	853mm	224W	90°	31800 lm	840	
MOALIN310L4W4GHT	1153mm	310W	90°	43000 lm	840	

## MEGAL



		O/F - 1-10V - Dali		Incl.
		80.000h L80 B50		5
		35° - 115°		>80 - >90
		IP 65 / IK 10		3000K - 4000K - 5700K - 6500K
		~mm H 90mm		

MOMEG730028435	655x197mm	49W	35°	7300 lm	840	
MOMEG1450048435	655x357mm	92W	35°	14500 lm	840	
MOMEG1450028435	1224x197mm	92W	35°	14500 lm	840	
MOMEG2950048435	1224x357mm	182W	35°	29500 lm	840	
MOMEG4400068435	1224x507mm	278W	35°	44000 lm	840	

## VLO



		O/F - Dali		Incl.
		80.000h L80 B50		5
		90°		>80
		IP 65 / IK 07		2700K - 3000K - 4000K - 5700K - 6500K
		~x136mm H 90mm		

MOVLO2500S2W4ND	660mm	19W	90°	2500 lm	840	
MOVLO7400M2W4ND	1270mm	49W	90°	7400 lm	840	
MOVLO10000L2W4ND	1570mm	75W	90°	10000 lm	840	
MOVLO13000L2W4ND		95W	90°	13000 lm	840	

## AQUOS



	O/F		Incl.
	50.000h L80 B10		5
	120°		>80
	IP 66 / IK 08		CCT 3000K/4000K/5000K
	~x85mm H 80mm		

IG101884	670mm	10-18W	120°	1400/2400 lm	840	
IG203684V2	1220mm	20-36W	120°	2700/5500 lm	840	
IG305484V2	1520mm	30-54W	120°	4200/8000 lm	840	

## AQUOS PRO



	O/F		Incl.
	50.000h L80 B10		5
	120°		>82
	IP 65 / IK 10		CCT 3000K/4500K/6000K
	~x84mm H 63mm		

IGAP1083060	600mm	10W	120°	1020-1200 lm	8~	
IGAP2083060	1200mm	20W	120°	2040-2400 lm	8~	
IGAP3083060	1500mm	30W	120°	3060-3600 lm	8~	
IGAP406083060	1500mm	40-60W	120°	4080-7200 lm	8~	

## MP



	O/F - Dali		Incl.
	50.000h L80 B50		5
	120°		>80
	IP 66 / IK 08		4000K
	~ x88mm H 82mm		

MOP2137840TW	1200mm	21-37W	120°	3400 - 5600 lm	840	
MOP2849840TW	1500mm	28-49W	120°	4600 - 7600 lm	840	

## TIP



	O/F - Dali		Incl.
	80.000h L80 B50		5
	60° - 110°		>80 - >90
	IP 23		2700K - 3000K - 4000K - 5700K - 6500K
	1584x145 mm H 73mm		

MOTIP63114840B		63-114W		9700-16100 lm	840	
----------------	--	---------	--	---------------	-----	--



## ALUMINA WP



	O/F - 1-10V - Dali		Incl.
	100.000h L80 B50		5
	30° - 60° - 90° - AS - DA		>80
	IP 66 / IK 10		3000K - 4000K
	105x~mm H 75mm		

CAALUS348460	1224mm	34W	60°	4390 lm	840	
CAALUS518460	1224mm	51W	60°	5986 lm	840	
CAALUM638460	1524mm	63W	60°	7482 lm	840	

## STORM EX



	O/F - Dali		Incl.
	50.000h L70		5
	120°		>80
	IP 66 / IK 10		4000K
	~mm H 140,5mm		

CASTORM40840	-40 - 60°c	1200mm	40W	120°	4400 lm	840	
CASTORS20840	-40 - 60°c	600mm	20W	120°	2200 lm	840	

## INNOTRACK MULTIFIT

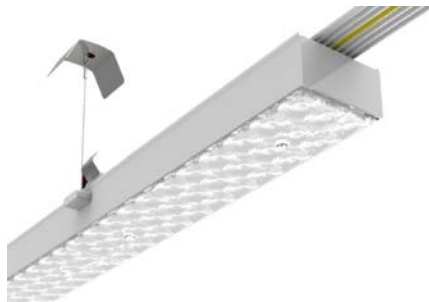

	Dali		Incl.
	72.000h L80 B10		5
	30° - 60° - 90° - 120°		>80
	IP 40		4000K - 6500K
	1528 x 66mm H 54mm		

IGMULTIFIT257584DWB	1500mm	25-75W		11250 lm	840	
IGMULTIFITTWPOWER		power set				
IGMULTIFOTTW1500	1500mm	cabling 7p				
IGMULTIFITTW300	3000mm	cabling 7p				



## POLAR



		Dali		Incl.
		60.000h L80 B10		5
		90° - 120°		>80
		IP 66 / IP 69K / IK 10		4000K
		140mm H ~mm		

CAPOLARS27840	1450mm	150W	120°	4000 lm	EX II	
CAPOLARM38840	1730mm	200w	120°	6000 lm	EX II	

## BRYAN PENDANT



		PC- Dali		Incl.
		100.000h L80 B10		5
		40°		>90
		IP 20		CCT 2700K/3000K/4000K/5700K
		~mm H mm		

LUBRYAN30930ALW		30W	40°	3050 lm	930	
LUBRYAN45930ALW		45W	40°	4500 lm	930	
LUBRYAN30930PCW		30W	40°	3050 lm	930	
LUBRYAN45930PCW		45W	40°	4500 lm	930	

## T-MAX



	O/F - Dali		Incl.
	100.000h L90 B10		5
	WB - MB - NB - AS		>70
	IP 66 / IP 69K / IK 09		3000K - 4000K
	278x428mm H ~mm		

CATMAXS112840WB	112W	14653 lm	840	
CATMAXM203840WB	203W	26400 lm	840	
CATMAXL408840WB	408W	56900 lm	840	

## RH



	O/F - Dali		Incl.
	50.000h L80 B50		5
	30° - 90° - AS		>80
	IP 65		3000K - 4000K - 5000K - 6500K
	200mm H ~mm		

MORH75840WB	95mm x H 138mm	75W	90°	10100 lm	840	
MORH155840WB	300mm x H 260mm	155W	90°	21500 lm	840	
MORH224840WB	480mm x H 260mm	224W	90°	31800 lm	840	

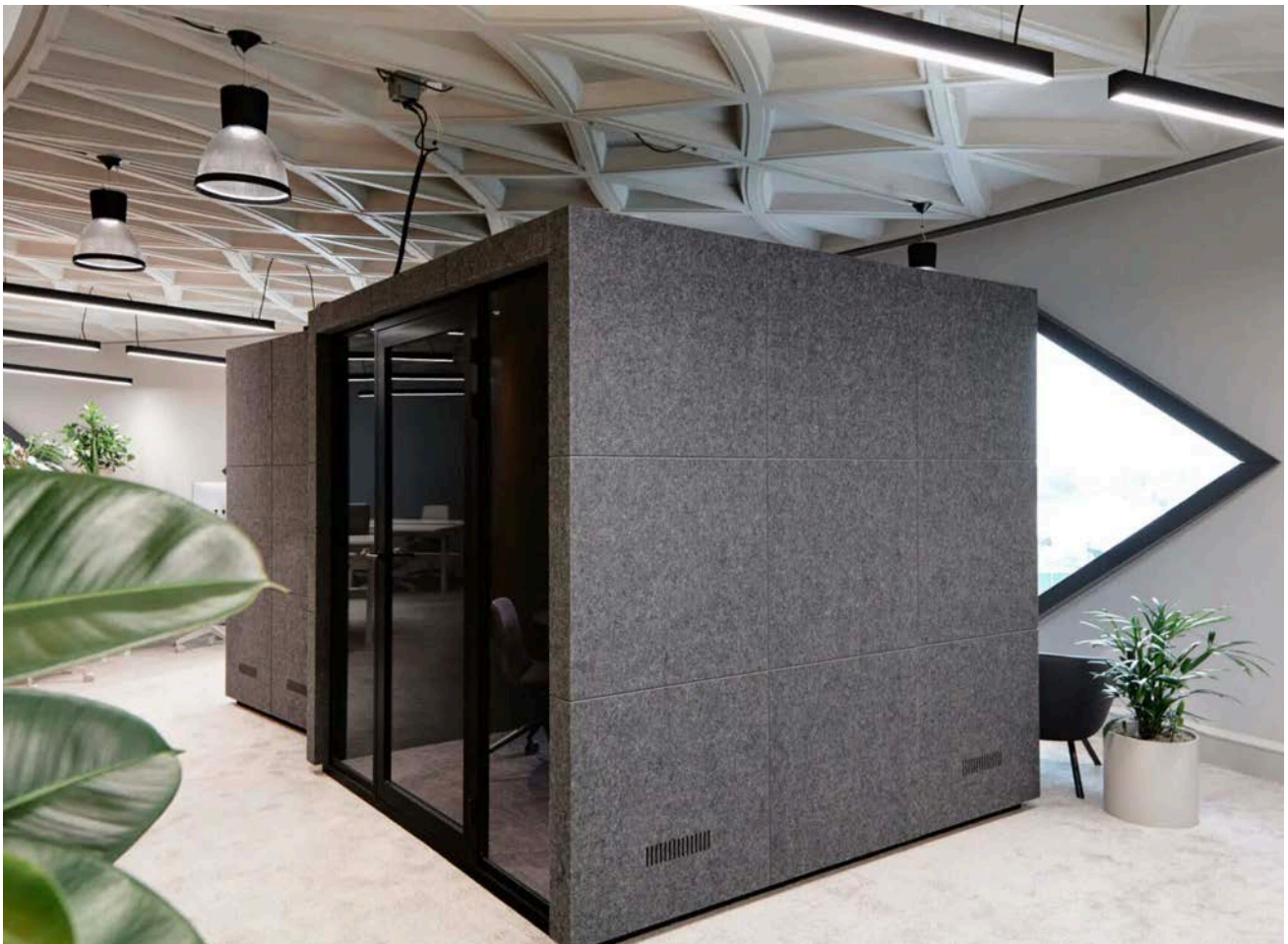

## HBL



	O/F - 0-10V - Dali		Incl.
	60.000h L80 B10		5
	90° - 120°		>80
	IP 65 / IK 08		4000K - 5000K
	~mm H ~mm		

EXHBLS1008490	254mm H 150mm	100W	90°	16458lm	840	
EXHBLM1468490	309mm H 156mm	146W	90°	23657 lm	840	
EXHBLL1998490	354mm H 161mm	199W	90°	30118 lm	840	

## POLAND GEN 2



	1-10V		Incl.
	50.000h		5
	110°		>80
	IP 65 / IK 08		CCT 3500K/4000K/5000K
	300mm H 165mm		

HOF161532218		100W/125W/150W	110°	15370/18250/22560 lm	8~	
HOF161538011	Light sensor BT					
HOF161538204	Black reflector					
HOF161538202	Protection grill					
HOF161538010	Sensor micro wave movement sensor					

## ATEX FIUL



	0-10V - Dali		Incl.
	50.000h		5
	60° - 120°		>70
	IP 65		3000K - 4000K - 5700K
	380x380mm H 125mm		160x322mm

TLFIU100740120	EX II	100W	120°	14000 lm	740	
TLFIU150740120	EX II	150W	120°	21000 lm	740	
TLFIU200740120	EX II	200W	120°	28000 lm	740	

## BENZIN LED



	O/F		Incl.
	200.000h L90 B10		5
	60°		>70
	IP 65		3000K - 4000K - 5000K
	490x350mm H 125mm		440x300

PR491662		96W	120°	13033 lm	740	
----------	--	-----	------	----------	-----	--

## JUPITA



EXLG13280

	1-10V		Incl.
	50.000h L80 B10		5
	60°/90°/105°		>80
	IP 65 / IK 08		CCT 3000K/4200K/5700K
	271mm H 215mm		
100W	~°	15500 lm	8~
150W		23250 lm	
200W		31000 lm	

## ISI

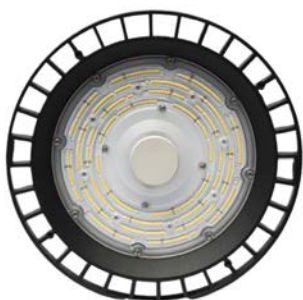

TLHBI10040120

TLHBI15040120

TLHBI20040120

	PC		Incl.
	50.000h		5
	120°		>80
	IP 65 / IK 10		4000K - 5000K
	~mm H ~mm		
100w	120°	14000 lm	
150W	120°	21000 lm	
200W	120°	28000 lm	

## TELLY



TLHBT2004060

TLHBT2004090

TLHBT20040120

	O/F - 1-10V - Dali		Incl.
	50.000h		5
	60° - 90° - 120°		>80
	IP 65		3000K - 4000K - 5500K
	~mm H ~mm		
200W	60°	37000 lm	840
200W	90°	37000 lm	840
200W	120°	37000 lm	840



# EXA UFO



	0-10V		Incl.
	50.000h		5
	90° - 120°		>80
	IP 65		4000K
	~mm H ~mm		

EXAUFO100840	238mm H 118mm	100W	120°	15000 lm	840	
EXAUFO2200840	324mm H 133mm	200W	120°	30000 lm	840	

# MALVA



	O/F		Incl.
	100.000h L80 B10		5
	90°		>80
	IP 66/ IP 69K / IK 10		4000K
	489mm H 166mm		

CAMALVA100200840		200W		28000 lm	840	
------------------	--	------	--	----------	-----	--





BUITEN  
EXTÉRIEUR





## SERBIA



		O/F - TRIAC		Incl.
		50.000h L80 B10		3
		50° - 80°		>80
		IP 67 / IK 09		3000K
		~mm H ~mm		108/133

HOF241111512	125mm H 98mm	9W	50°	720 lm	830	
HOF241121512	145mm H 105mm	20W	80°	1400 lm	830	

## UKRAINE



		O/F - TRIAC		Incl.
		50.000h L80 B10		3
		25°		>80
		IP 67 / IK 08		3000K
		120mm H 155mm		115

HOF242101512		6W	25°	600 lm	830	
--------------	--	----	-----	--------	-----	--

## GROUND ROUND



		O/F		Incl.
		90.000h		3
		10° - 25° - 50° - AS - WW - 24x50° - 50x24°		>80
		IP 67		2700K - 3000K - 4000K
		288mm H 175mm		

FR107604.3.01		26W	10°	2652 lm	830	
FR107614.3.03		45W	50°	5581 lm	830	

# DUBLIN

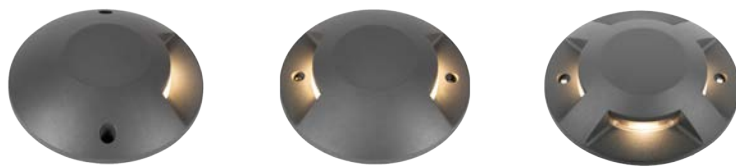

		O/F		Incl.
		50.000h L80 B10		3
		36°		>80
		IP 67		3000K
		200mm H 42mm		

HOF241211312	6W	36°	110 lm	830	
HOF241221312	2x6W	2x36°	140 lm	830	
HOF241241312	4x3W	4x36°	205 lm	830	

# CIUTAT



		O/F		Incl.
		65.000h L80 B10		5
		AS - 45° - 60°		>80
		IP 66 / IK 06		2700K - 3000K - 4000K
		165mm H 99mm		150

NE24600-YGA2	165mm x 99mm	13W	AS	1500 lm	827	
NE24602-OC42		13W	45°	1500 lm	830	
NE24602-YN62		13W	60°	1500 lm	840	



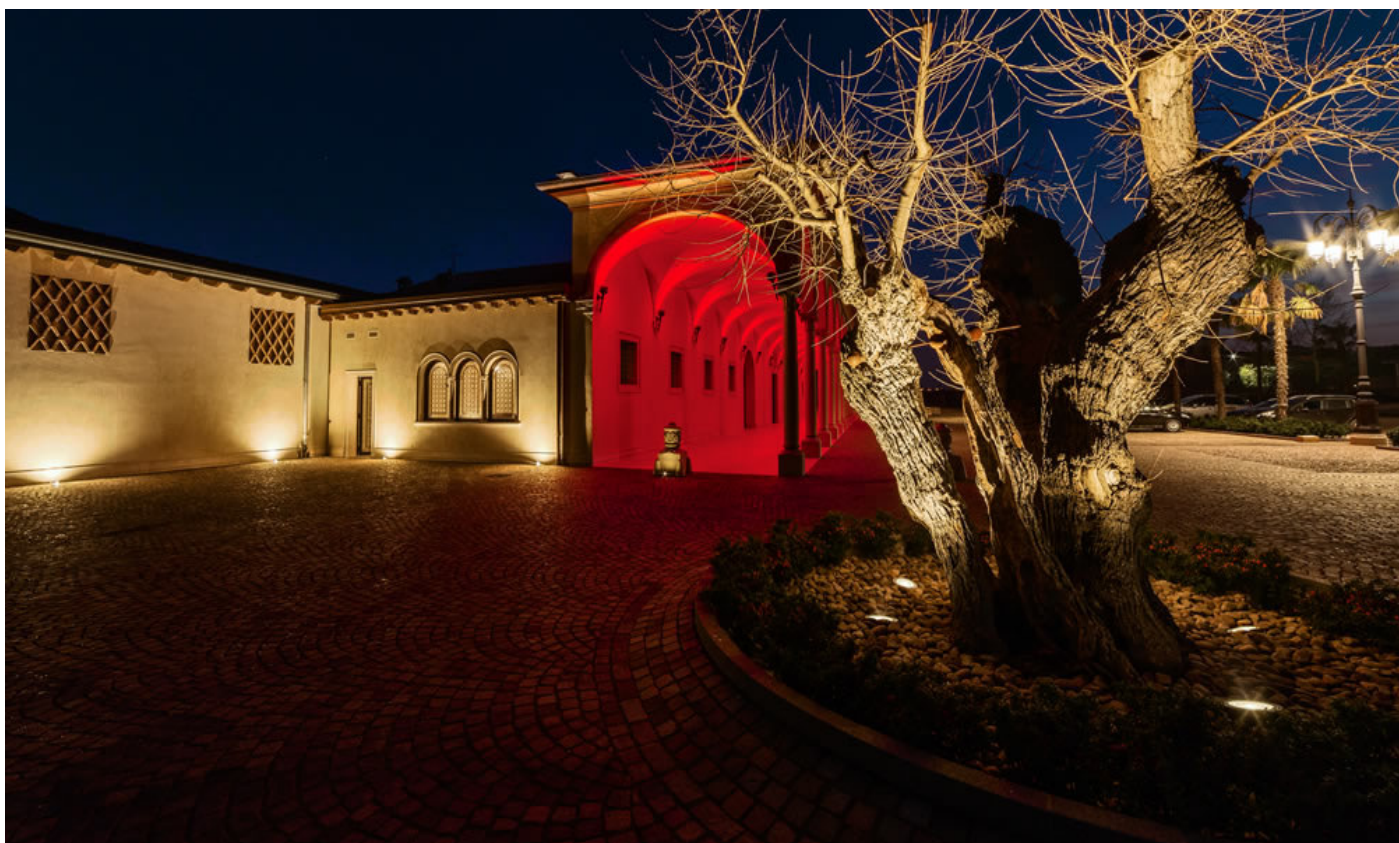

## FLEA H2O



A



B

	O/F		Excl.
	90.000h		3
	10° - 25° - 30° - 45° - 14x20° - O		>80
	IP 68		2700K - 3000K - 4000K
	~mm H ~mm		

FR501036.3.02	A	35mm H 130,5mm	2W	30°	150 lm	830	
FR501146.3.02	A	50mm H 130,5mm	4W	30°	411 lm	830	
FR501276.3.36	A	80mm H 131,4mm	8,5W	25°	464 lm	830	
FR501326.3.02	B	35mm H 51mm	2W	30°	150 lm	830	
FR501346.3.02	B	50mm H 94mm	4W	30°	411 lm	830	
FR501426.3.36	B	80mm H 107,5mm	8,5W	25°	464 lm	830	

## BELGIUM



	O/F		Incl.
	50.000h L80 B10		3
	20°		>80
	IP 65		3000K
	~mm H ~mm		

HOF252011312		66x103mm H 91mm	5W	20°	210 lm	830	
HOF252031312		105x105mm H 142mm	12W	20°	630 lm	830	
HOF252041312		124x125mm H 157mm	14W	20°	840 lm	830	

## EGO H2O



	O/F		Excl.
	55.000h		3
	12° - 24° - 38°		>80
	IP 68		3000K - 4000K
	~mm H ~mm		

FR504016.3.12	132mm H 167mm	A	9W	24°	1124 lm	830	
FR504056.3.12	115mm H 164mm	B	9W	24°	1124 lm	830	
FR504226.3.12	204mm H 154mm	A	12W	24°	1416 lm	830	
FR504266.3.12	181mm H 248mm	B	12W	24°	1416 lm	830	

## RONDA



	O/F		Incl.
	65.000h L80 B10		5
	20° - 24° - 36° - 40°		>80
	IP 65 / IK 06		2700K - 3000K - 4000K
	~mm H ~mm		

NE24101-YC30	60mm H 412mm	6W	36°	700 lm	830	
NE24101-YC31		9W	36°	1000 lm	830	
NE24102-YC32	80mm H 433mm	13W	36°	1500 lm	830	
NE24102-YC33		17,5W	36°	2100 lm	830	
NE24103-YC44	116mm H 632mm	25,5W	40°	3400 lm	830	



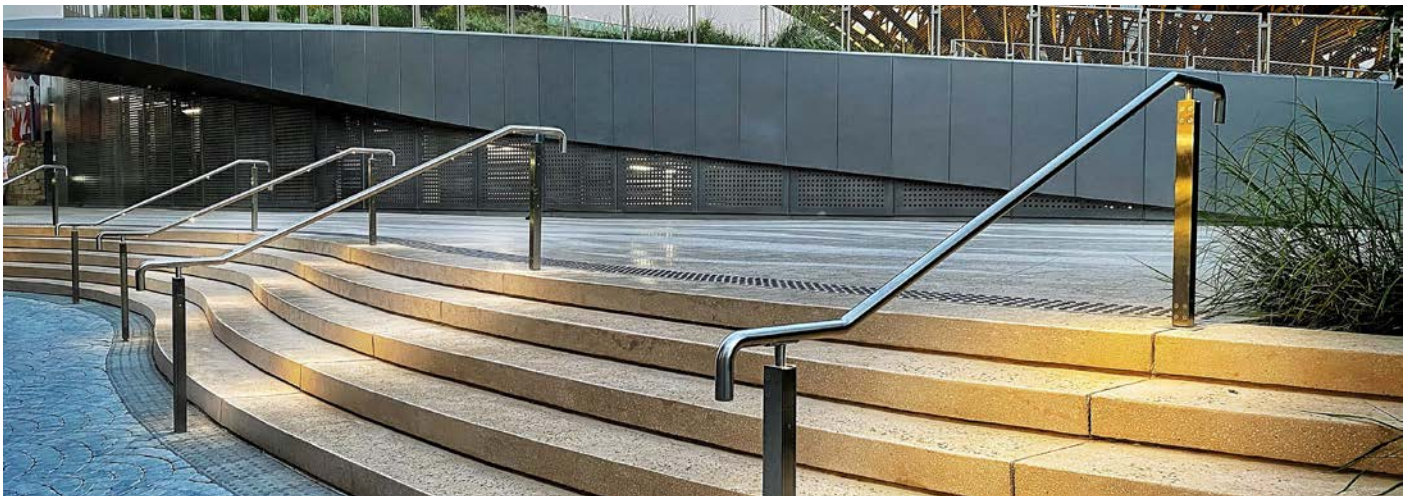

## HAITI



		O/F		Incl.
		50.000h L80 B10		3
		18 - 60°		>80
		IP 65		3000K
		70x135mm H 270mm		

HOF252111312

11W 18-60° 480 lm 830

## SQUARE MCI



		O/F - DMX - Dali		Excl.
		70.000h L80 B10		5
		9° - 20° - 40° - 48x10° - 10x48°		>80
		IP 65		AMB - 2700K - 3000K - 4000K - SW - RGBW - CCT 2700K/5000K
		~x180mm H 42mm		

MCI7502000803K 78mm 13W 40° 691 lm 830

MCI7502200803K 139mm 25W 40° 1382 lm 830

## SLIM LINE GRAZER



		O/F - DMX - Dali		Excl.
		60.000h L80 B10		5
		10° - 25° - 40° - 55° - 60° - 75° - 15x55° - AS		>80
		IP 66		AMB - 2700K - 3000K - 4000K - CCT 1800K/4000K
		44x ~mm H 80mm		

MCI75214102803K 615mm 38W 60° 3414 lm 830

MCI75214103803K 910mm 55W 60° 5122 lm 830

MCI75214104803K 1205mm 73W 60° 6829 lm 830

MCI75214105803K 1500mm 91W 60° 8536 lm 830



## DENMARK 6



A



B

		O/F		Incl.
		50.000h L80 B10		3
		55°		>80
		IP 54		3000K
		80mm H 105mm		

HOF22021112	A	6W	55°	300 lm	830	
HOF220211312		6W	55°	300 lm	830	
HOF220221112	B	6W	55°	300 lm	830	
HOF220221312		6W	55°	300 lm	830	

## CALA CEILING



		O/F		Incl.
		50.000h L80 B10		5
		15° - 20° - 36° - 40° - 50° - 70°		>80 - >90
		IP 65		2700K - 3000K - 4000K
		~mm H ~mm		

NE24201-YC32	80mm H 136mm	13W	36°	1500 lm	830	
NE24201-YC33		17,5W	36°	2100 lm	830	
NE24202-YC43	110mm H 160mm	18W	40°	2500 lm	830	
NE24202-YC44		25,5W	40°	3400 lm	830	
NE24203-YC45	150mm H 185mm	38W	40°	4900 lm	830	
NE24203-YC47		45W	40°	5420 lm	830	

## CALA WALL



		O/F		Incl.
		50.000h L80 B10		5
		15° - 20° - 36° - 40° - 50° - 60° - 70°		>80
		IP 65		2700K - 3000K - 4000K
		~mm H ~mm		

NE24401-YC32	80mm H 155mm	13W	36°	1500 lm	830	
NE24410-YC32	80mm H 260mm	2x13W	36°	2x1500 lm	830	
NE24402-YC43	110mm H 160mm	18W	40°	2500 lm	830	
NE24411-YC43	110mm H 320mm	2x18W	40°	2x2500 lm	830	
NE24403-YC44	150mm H 180mm	25,5W	40°	3400 lm	830	
NE24412-YC44	150mm H 360mm	2x25,5W	40°	2x3400 lm	830	

## BENIN



		O/F		Incl.
		50.000h L80 B10		3
		30° - 45°		>80
		IP 54		3000K
		80mm H ~mm		

HOF230711312	95mm	6W	45°	400 lm	830	
HOF230721312	138mm	2x6W	2x30°	800 lm	830	



## DUBAI 20



		O/F		Incl.
		50.000h L80 B10		3
		18°		>80
		IP 65		3000K
		140mm H 185mm		

HOF230811112	20W	18°	1200 lm	830	
HOF230811312	20W	18°	1200 lm	830	

## DUBAI 40 UP/DOWN



		O/F		Incl.
		50.000h L80 B10		3
		18°		>80
		IP 65		3000K
		140mm H 300mm		

HOF230821112	2x20W	2x18°	2400 lm	830	
HOF230821312	2x20W	2x18°	2400 lm	830	

## GHANA



		O/F		Incl.
		50.000h L80 B10		3
		35°		>80
		IP 54		3000K
		100x100mm H 100mm		

HOF230111312	6W	35°	410 lm	830	
HOF230121312	2x6W	2x35°	775 lm	830	

## CARRER



		O/F		Incl.
		65.000h L80 B10		5
		100°		>80
		IP 65		CCT 3000K/4000K
		200x150mm H 75mm		176x130

NE24500-YS91	176x130mm	10W	100°	1000 lm	S	
NE24500-OS91		10W	100°	1000 lm	S	

## BERGEN

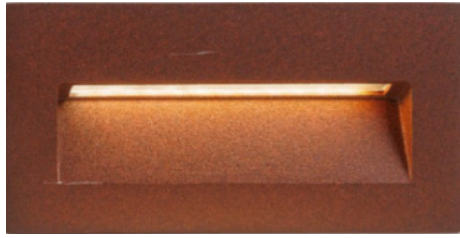

		O/F		Incl.
		35.000h		3
		60°		>80
		IP 65 / IK06		CCT 2200K/2700K/ 3000K/4000K
		151x76mm H 72mm		141x66

HOF240231118	5W	60°	345/370/390/420 lm	8~	
HOF240231318	5W	60°	345/370/390/420 lm	8~	
HOF240231618	5W	60°	345/370/390/420 lm	8~	

## OSLO



		O/F		Incl.
		50.000h L80 B10		3
		0 - 100°		>80
		IP 54		3000K
		140x145mm H 127mm		

HOF230251112	9W	0 - 100°	375 lm	830	
HOF230251312	9W	0 - 100°	375 lm	830	

## PASSEIG



		O/F		Incl.
		65.000h L80 B10		5
		40°		>80
		IP 65 / IK 06		CCT 3000K / 4000K
		170x12mm H 42mm		

NE24304-YS0	4,5W	600 lm	8~	
NE24304-YS1	6W	800 lm	8~	



## BOW



		O/F - DMX - Dali		Incl.
		70.000h L80 B10		5
		180x15°		>80
		IP 65		1800K - 2700K - 3000K - 4000K
		100x120mm H 49mm		

MCI71327101803K

6W 180x15° 174 lm 830

MCI71327102803K

10W 180x15° 320 lm 830

## VLOK DOWN



		O/F - PC - Dali		Incl.
		65.000h L80 B10		5
		20° - 36°		>90
		IP 65		2700K - 3000K - 4000K
		~mm H 75mm		

NE24226-0H21

167 x 38mm

12W 20° 1260 lm 927

NE24226-0E31

12W 36° 1260 lm 930

NE24226-0F31

12W 36° 1260 lm 940

NE24232-0H22

326 x 38mm

18W 20° 1800 lm 927

NE24232-0E32

18W 36° 1800 lm 930

NE24232-0F32

18W 36° 1800 lm 940

## VLOK WALL



		O/F - PC - Dali		Incl.
		65.000h L80 B10		5
		20° - 36°		>90
		IP 65		2700K - 3000K - 4000K
		~mm H 50mm		

NE24446-1H21

172mm x 72mm

12W 20° 1260 lm 927

NE24446-1E31

12W 36° 1260 lm 930

NE24446-1F31

12W 36° 1260 lm 940

NE24452-1H22

300mm x 72mm

18W 20° 1800 lm 927

NE24452-1E32

18W 36° 1800 lm 930

NE24452-1F32

18W 36° 1800 lm 940

## VLOK RECESSED



		O/F - PC - Dali		Incl.
		65.000h L80 B10		5
		20° - 36°		>90
		IP 65		2700K - 3000K - 4000K
		~mm H 495mm		*

NE24613-1H20	95mm x 45mm / *87x37mm	8W	20°	630 lm	927	
NE24613-1E30		8W	36°	630 lm	930	
NE24616-1F21	174mm x 45mm / *165x37mm	15W	20°	1260 lm	940	
NE24616-1H31		15W	36°	1260 lm	927	
NE24622-1E23	333mm x 45mm / *325x37mm	28W	20°	2520 lm	930	
NE24622-1F33		28W	36°	2520 lm	940	



# MULTI WALLPACK



	O/F		Incl.
	50.000h		5
	120°		>80
	IP 65 / IK 10		CCT 3000K/4000K/5000K
	248x108mm H 108mm		

AGWALLPACKMULTICCT

15-30W      120°      150 lm/W      8~     





## IVO



	O/F		Incl.
	30.000h L70 B50		3
	120°		>80
	IP 65 / IK 07		RGB+TW - 3000K - 4000K
	~mm H ~mm		

TLPRIS20401202	S	120x160x30mm	20W	120°	2000 lm	840	
TLPRIS30401202	S	160x225x30mm	30W	120°	3000 lm	840	
TLPRIS50401202	S	180x250x30mm	50W	120°	5000 lm	840	
TLPRIB30RGB1202		160x225x30mm	30W	120°	2400-3000 lm	RGB +3000K-6000K	

## LYON



	0-10V - Dali -DMX		Incl.
	50.000h L70 B10		5
	15° - 30° - 60° - 90° - 120° - 60x20° - 156x71°		>80
	IP 66 / IK 08		3000K - 4000K - 5700K
	~mm H ~mm		

TLPRL02030120		182,4x206,1x85,2mm	20W	120°	3000 lm	830	
TLPRL0304015		182,4x206,1x85,2mm	30W	15°	4650 lm	840	
TLPRL0504030		235,5x283,8x110,7mm	50W	30°	7750 lm	840	
TLPRL10030A11		311x372,2x137,1mm	100W	AS11	15000 lm	830	
TLPRL20030A11		363x438x146mm	200W	AS11	30000 lm	830	
TLPRL30040A11		456,5x608x182mm	300W	AS11	46500 lm	840	
TLPRL40040A11		456,5x608x182mm	400W	AS11	62000 lm	840	



## PANAMA



	O/F - Dali- 1-10V		Incl.
	50.000h L70 B50		5
	45° - 60° - 120°		>70
	IP 65		3000K- 4000K - 5700K
	~mm H ~mm		

TLPQM104NN73004	1	292,6x189mm H 54mm	40W	45°	6460 lm	730	
TLPQM208NN74006	2	292,6x269mm H 54mm	80W	60°	13328 lm	730	
TLPQM312NN74012	3	292,6x349mm H 54mm	120W	120°	19992 lm	730	
TLPQM416NN75704	4	292,6x429mm H 54mm	160W	45°	27200 lm	757	

## CUBIC CCT



	1-10V - PWM		Incl.
	50.000h L80 B10		5
	120°x90° - AS		>80
	IP 65 / IK 08		CCT 3000K /4000K/5000K
	~mm H ~mm		

IGCU415508385B		247x238mm H 74mm	15-50W		2260 - 7010 lm	CCT	
IGCU4801508385B		407x347mm H 85mm	80-150W		11200 - 22050 lm	CCT	
IGCU42003008385B		594x357mm H 95mm	200-300W		28000 - 42600 lm	CCT	

## OLYMPIC 2



1 2 3

	0-10V - Dali - DMX		Incl.
	50.000h L80 B10		5
	15° - 30° - 60° - 90° - 117x34°		>70
	IP 66 / IK 08		4000K - 5700K
	~mm H ~mm		

TLOLP03004015	1	514,2x191,5mm H 164,3mm	300W	15°	40500 lm	840	
TLOLP060040AS	2	558,4x354,43mm H 384,65mm	600W	AS	99000 lm	840	
TLOLP09004090	3	558,4x524,43mm H 384,65mm	900W	90°	148500 lm	840	
TLOLP15004030	3	558,4x524,43mm H 384,65mm	1500W	30°	247500 lm	840	
TLOLP12004060	4	558,4x524,43mm H 384,65mm	1200W	60°	198000 lm	840	

## RUA S/M/L



	1-10V - Dali - DN2- - DN2+ - DRC - DPR		Incl.
	100.000h L80 B10		5
	60x150°- 50x150°- 45x150°- 75x150°- 37x115°- 55x145°- 31x110°- 140°		>70
	IP 66 / IK 08		2700K - 4000K - 5700K
	~mm H ~mm		

TLCVS003A1		613x222x159mm	20W	60x150°	2410 lm	727	
TLCVS008A1		613x222x159mm	40W	60x150°	5160 lm	740	
TLCVM011A1		680x282x160mm	80W	60x150°	10320 lm	740	
TLCVL005A2		763x352x167mm	120W	50x150°	15600 lm	740	
TLCVL007A2		763x352x167mm	150W	50x150°	18383 lm	740	

## KALE S/M/L/XL



	O/F - Dali		Incl.
	50.000h L80 B10		5
	150° - 151x81° - 142x72° - 156x71° - 100x65°		>80
	IP 66 / IK 08		3000K - 4000K
	~mm H ~mm		

TLKVS03040A14		534,7x192,47x82,5mm	30W	156x71°	4200 lm	840	
TLKVM08040A14		577x222,23x87,5mm	80W	156x71°	11200 lm	840	
TLKVL12040A14		667x285,97x90,5mm	120W	156x71°	15600 lm	840	
TLKVXL20040A14		764,5x312x90,5mm	200W	156x71°	28000 lm	840	
TLKVXL24040150		764,5x312x90,5mm	240W	150°	33600 lm	840	



## JAMAICA



	O/F	Incl.
	35.000h	3
	120°	>80
	IP 65 / IK 08	CCT 3000K/4000K
	220x140mm H 450mm	

HOF270131318

13,5W 120° 1000/1050 lm 8~

## CYPRUS



	O/F	Incl.
	50.000h L80 B10	3
	360°	80
	IP 65 / IK 08	3000K
	120mm H 800mm	

HOF270151112

12W 360° 650 lm 830

HOF270151312

12W 360° 650 lm 830

## BELIZE



	O/F	Incl.
	35.000h	3
	360°	>80
	IP 65 / IK 06	2700K - 3000K
	108mm H ~mm	

HOF270201312

250mm

8W 360° 290 lm 830

HOF270211312

650mm

8W 360° 290 lm 830

## AALBORG



		O/F		Incl.
		35.000h		3
		90°		>80
		IP 65		CCT 2200K/2700K/3200K/4000K
		160x160mm		

HOF270111318

9W 90° 700-900 lm 8~

HOF270121318

9W 90° 700-900 lm 8~

## STOCKHOLM



		O/F		Excl.
		35.000h		3
		45°		>80
		IP 65 / IK 08		CCT 2200K/2700K/3200K/4000K
		130mm x 60mm H ~ mm		

HOF270161118

350mm

9W 45° 580-710 lm 8~

HOF270161318

9W 45° 580-710 lm 8~

HOF270161618

9W 45° 580-710 lm 8~

HOF270171118

600mm

9W 45° 580-710 lm 8~

HOF270171318

9W 45° 580-710 lm 8~

HOF270171618

9W 45° 580-710 lm 8~

## PLACA



1



2

		O/F		Incl.
		65.000h L80 B10		5
		2 R		80
		IP 65		2700K - 3000K - 4000K
		45x160mm H 356mm		

NE24430-YC0

1

6W 2 R 800 lm 830

NE24431-YC0

2

6W 2 R 800 lm 830

### Extra

NE24491-Y

VBG 350mm

NE24492-Y

VBG 650mm

NE24993-8

BCL

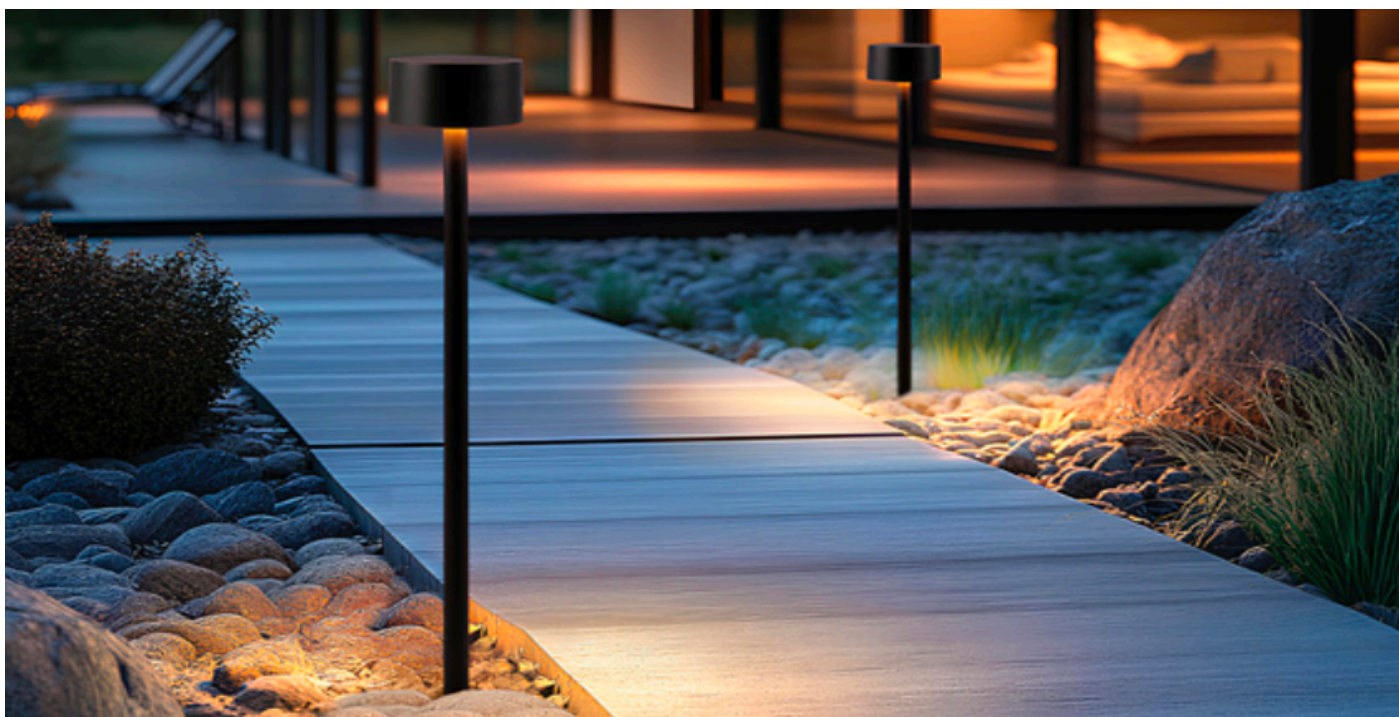

## PIN BOLLARD



		O/F		Incl.
	55.000h L80 B10		3	
	1 R - 2 R		>85	
	IP 65		2700K - 3000K - 4000K	
	70x70mm H ~mm			

FR610014.4.64	240mm	8W	1 R	469 lm	840	
FR610024.4.67		8W	2 R	469 lm	840	
FR610254.4.64	605mm	14W	1 R	937 lm	840	
FR610264.4.67		14W	2 R	1190 lm	840	

## VERSAILLES



		O/F		Incl.
	50.000h		3	
	120°		>80	
	IP 65 / IK 08		CCT 2200K/3000K	
	100x650mm			

HOF270191318		7W	120°	450/490 lm	8~	
HOF270198002	Dome cover					
HOF270198001	Cylindrical cover					
HOF270198005	Base					
HOF270198006	Spike					



## TWIGGY LESS



			DT		Incl. (USB)
			30.000h		3
			100°		>80
			IP 65		CCT 2700K/3000K
			110mm H 350mm		

MC42754	9h	2,2W	100°	150 lm	8~	
MC42755	9h	2,2W	100°	150 lm	8~	
MC42753	9h	2,2W	100°	150 lm	8~	
MC42761	9h	2,2W	100°	150 lm	8~	
MC42756	9h	2,2W	100°	150 lm	8~	

## DIOGENE



		DT		Incl. (USB)
		30.000h		3
		120°		>80
		IP 65		CCT 2700K/3000K
		150x150mm H ~mm		

MC42721	300mm	9h	2,2W	120°	200 lm	8~	
MC42722			2,2W	120°	200 lm	8~	
MC42720			2,2W	120°	200 lm	8~	
MC42725	500mm	9h	2,2W	120°	200 lm	8~	
MC42726			2,2W	120°	200 lm	8~	
MC42724			2,2W	120°	200 lm	8~	

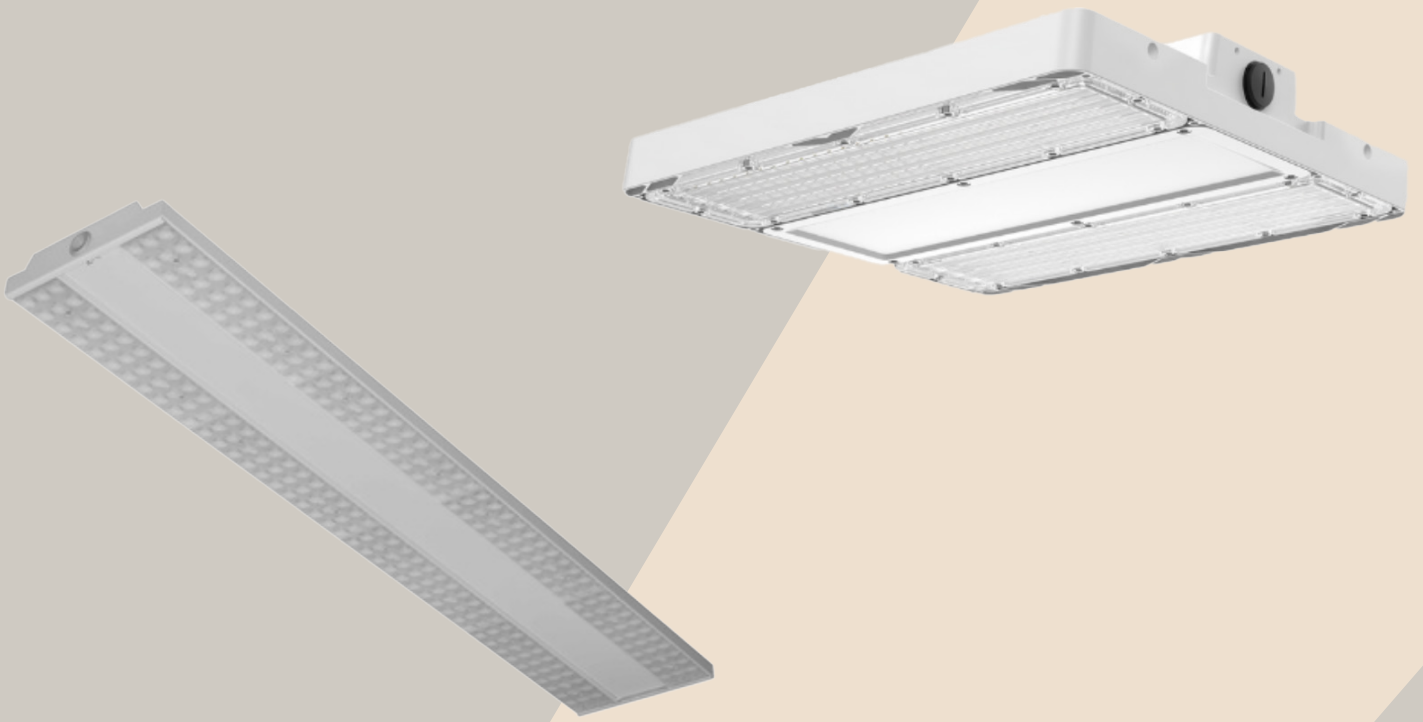

SPORT



# ACTIVE



		Dali		Incl.
	100.000h L80 B10		5	
	WB		>80	
	IP 66 / IK 10		4000K	
	~mm H ~mm			

CARACTIVE100840WBDA	2	340x350mm H 62mm	100W	WB	15000 lm	840	
CARACTIVE15840WBDA	2		150W	WB	22000 lm	840	
CARACTIVE200840WBDA	1	680x350mm H 62mm	200W	WB	31000 lm	840	
CARACTIVE24840WBDA	1		240W	WB	37000 lm	840	

# GAME

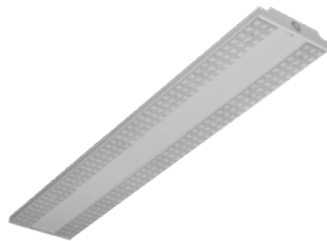

		O/F - Dali		Incl.
		80.000h L80 B50		5
		30° - 60° - 90° - AS		>80
		IP 40		2700K - 3000K - 4000K - 5700K - 6500K
		~x213mm H 42mm		

MOGAMEM60988490G	1165mm	60-98W	90°	11100-17400 lm	840	
MOGAMEL1308490G	1735mm	130W	90°	22500 lm	840	



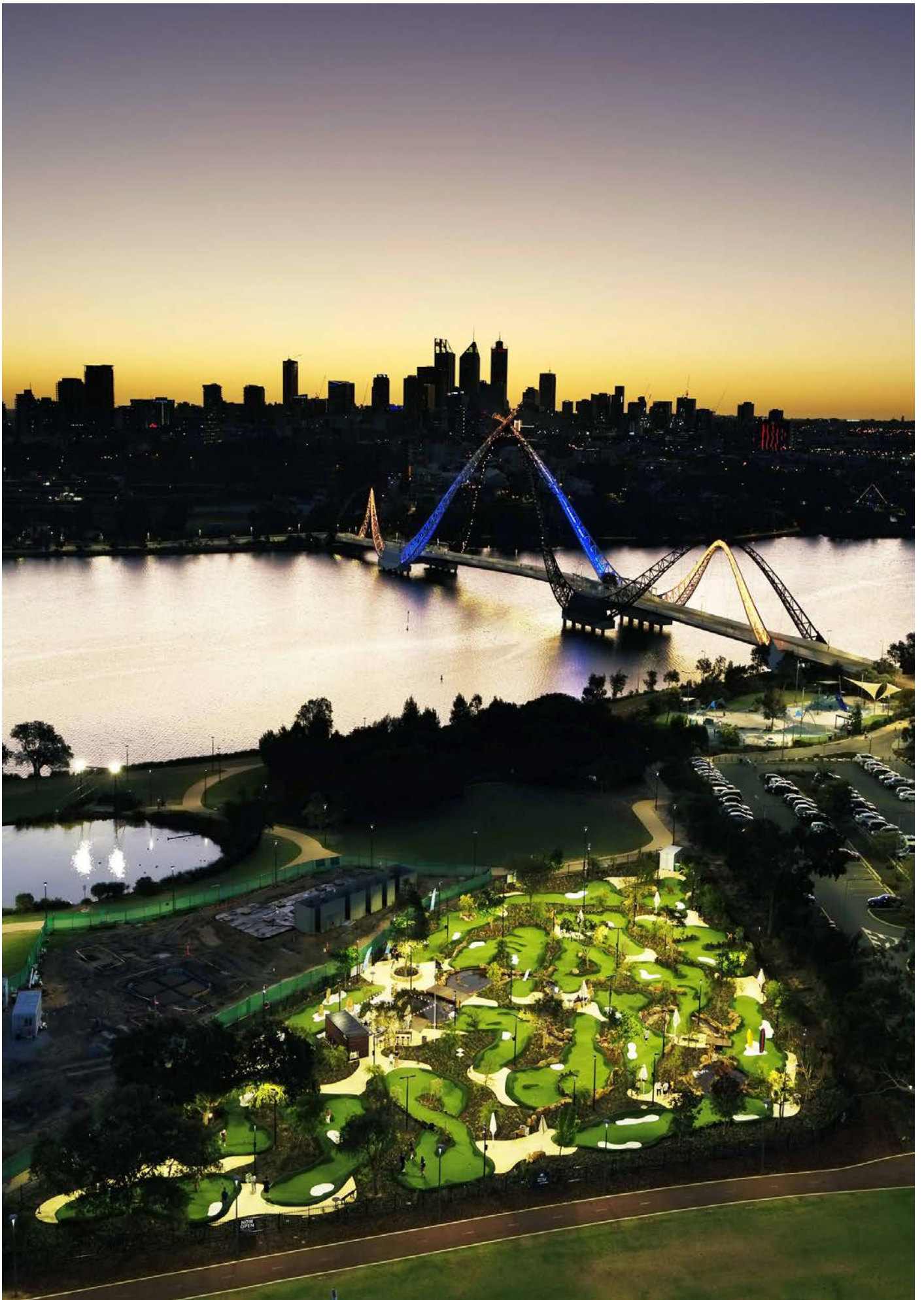



	O/F - Dali		Incl.
	50.000h L85 B50		5
	90°		>80
	IP 20		3000K - 4000K
	1540x~mm H 95mm		

SI51HS12DC3DCA	315mm	58W	90°	7500 lm	830	
SI51HS12DC4DCA		58W	90°	8000 lm	840	
SI51HS12DC4ECA		88W	90°	12000 lm	840	
SI51HS12DD4GCA	415mm	117W	90°	16000 lm	840	
SI51HS12DD4JCA		146W	90°	20000 lm	840	





ZONNE-  
ENERGIE  
SOLAIRE



## CERES SOLAR



	O/F		Incl.			
	100.000h L90 B10		5			
	60°		>70			
	IP 65 / IK 08		2200K - 3000K - 4000K			
	~mm H 133mm					
CACERESS27740	560x366mm	27W	60°	5400 lm	740	
CACERESM40740	750x366mm	40W	60°	7800 lm	740	

## HADAR



	O/F		Incl.			
	25.000h L70 B50		2			
	120°		>80			
	IP 65		3000K - 4000K			
	230x97mm H 42,7mm					
PR590723		6W	120°	796 lm	840	
PR590747		6W	120°	796 lm	840	

## DRACO



	O/F		Incl.			
	35.000h L70 B50		2			
	120°		>80			
	IP 65		3000K - 4000K			
	492,5x232mm H 58mm					
PR590631		15W	120°	1916 lm	840	

## ZENIT



	Dali		Incl.			
	100.000h L90 B10		5			
	WB - MB - AS		>70			
	IP 65 / IK 10		2200K - 2700K - 3000K - 4000K			
	436,6x210,4mm H 100mm					
CAZENITH100730		100W		340 lm	730	



# NEBIRA



	O/F		Incl.
	50.000h L70 B10		5
	100°x40°		>80
	IP 66 / IK 08		3000K - 4000K
	255x595mm H 120mm		

PR636537		14,5W	100°x40°	2759 lm	830	
PR636544		14,5W	100°x40°	2972 lm	840	
PR636551		30,5W	100°x40°	5912 lm	830	
PR636575		30,5W	100°x40°	6192 lm	840	
PR640534	Remote controle					

# VORONA SWITCH



	PC		Incl.
	50.000h		3
	360°		>80
	IP 65		CCT 3000K/4000K
	400x400mm H 120mm		

PR640947		20W		2407/2511 lm	8~	
----------	--	-----	--	--------------	----	--

# MINIC



	O/F		Incl.
	25.000h L70 B50		2
	360°		>80
	IP 44 / IK 04		3000K - 4000K
	mm H ~mm		

PR662215	2	160x178mm	4,4W	410 lm	830	
PR662208	2		4,4W	436 lm	840	
PR662239	1	160x500mm	4,4W	410 lm	830	
PR662222	1		4,4W	436 lm	840	

# GALLIOT



		O/F		Incl.
		25.000h L70 B50		2
		180°		>80
		IP 44 / IK 04		3000K - 4000K
		~mm H ~mm		

PR662284	1	131x181x500mm	4,4W	410 lm	830	
PR662277	1		4,4W	436 lm	840	
PR662253	2	135x168x69mm	4,4W	410 lm	830	
PR662246	2		4,4W	436 lm	840	





## KENYI SWITCH



	O/F		Incl.
	54.000h L70 B50		3
	120°		>80
	IP 65 / IK 07		CCT 3000K/4000K
	~mm H ~mm		

PR679589	10W	1500 lm	
PR679596	30W	4800 lm	
PR679602	60W	9600 lm	

## IVO SOLAR



	O/F		Incl.
	30.000h L70 B50		3
	120°		>80
	IP 65 / IK 07		3000K - 4000K - 6000K
	~mm H ~mm		

TLSPRI20401202	Solar	120x160x30mm	20W	120°	2000 lm	840	
TLSPRI30401202	Solar	160x225x30mm	30W	120°	3000 lm	840	
TLSPRI50401202	Solar	120x160x30mm	50W	120°	5000 lm	840	



NOOD  
SECOURS



## PRODIGY



		O/F		Incl.
		50.000h L80 B10		5
		120°		>80
		IP 42		4000K
		243x114mm H 33mm		

LIL27203/B	2,2W	1h	175 lm	<input type="checkbox"/>
LIL27206/B	2,7W	1h	280 lm	<input type="checkbox"/>

## STEP LED



		O/F		Incl.
		50.000h L80 B10		5
		120°		>80
		IP 42		4000K
		337x155mm H 53mm		

LIL10003	4,2W		200 lm	<input type="checkbox"/>
LIL10203	5,2W		450 lm	<input type="checkbox"/>
LIL10403	9,5W		730 lm	<input type="checkbox"/>

## FORZA



		O/F		Incl.
		50.000h L80 B10		5
		150°		>80
		IP 65 / IK 10		3000K - 4000K
		338x157mm H 79mm		

LIL1200W	9W		720 lm	<input type="checkbox"/>
LIL1200W-DET	9W		720 lm	<input type="checkbox"/>
LIL1212W-SE	9W	1h	720 lm	<input type="checkbox"/>
LIL1212W-SE-DET	9W	1h	720 lm	<input type="checkbox"/>

## VIALED EVO MINIBOX



		O/F		Incl.
		50.000h L80 B10		5
		WB - DA		>80
		IP 42		4000K
		130x130mm H 40mm		

LIL8121/B-BOX	5,7W	1h	410 lm	840	<input type="checkbox"/>
LIL8122/B-BOX	5,7W	3h	410 lm	840	<input type="checkbox"/>

## VIALED EVO



		O/F		Incl.
		50.000h L80 B10		5
		WB - DA		>80
		IP 20 / IP 42		4000K
		85mm H 32mm		65

LIL8121/B	P/NP	5,7W	1h	450 lm	840	
LIL8122/B	P/NP	4,8W	3h	360 lm	840	

## VIALED IP65



		O/F		Incl.
		50.000h L80 B10		5
		WB - DA		>80
		IP 65		4000K
		85mm H 32mm		65

LIL8101/B		7,8W	2h	750 lm	840	
-----------	--	------	----	--------	-----	--



# MOON



		O/F		Incl.
		40.000h		4
		120°		>80
		IP 54 / IK 08		CCT 3000K/4000K
		300mm H 48mm		

LIL3652		18W	1700/1950 lm	
LIL3652-DET	S	18W	1700/1950 lm	
LIL3652-SE	NOOD 3h	18W	1700/1950 lm	
LIL3652-SE-DET	NOOD 3h + S	18W	1700/1950 lm	

# SPACE



		O/F		Incl.
		50.000h L80 B10		5
		60°		>80
		IP 20 / IK 02		5000K
		212x63mm H 98mm		

LIL2003/B		6W	3h	220 lm	
LIL2003/N		6W	3h	220 lm	





## MINI ROUND



		O/F		Incl.
		50.000h L80 B10		5
		120°		>80
		IP 40		4000K
		80mm H 37mm		52

LILLMR1001

P/NP

1W

3h

50 lm

840



## TWINLIGHT



		O/F		Incl.
		50.000h L80 B10		5
		60°		>80
		IP 65 / IK 08		6000K
		340x302mm H 90mm		

LIL25025

P/NP

2x20W

3600 lm

860



LIL25025-AUT

P/NP

2x20W

3600 lm

860



# Index A-Z

Product	P				
3F Brackets	116	Boxet Adjustable	36	Flat AR45-LED Round	11
3F Connector	115	Boxet Fix	35	Flat FR55-LED Round	12
3F Feeder	115	Brag	125	Flat FR68-LED Round	12
3F Rails	114	Brussels	64	Flat FR68-LED Square	14
3F Surface Mounted Base Track Adapter	116	Bryan Pendant	148	Flea H2O	156
3F Suspension	116	Bud	34	Fors	127
Aalborg	170	Cala Ceiling	159	Forza	184
Accessoires Micropolis & Tripolis	40	Cala Wall	160	Frame LEDpanels	48
Active	174	Canada gen 2	39	FUL	29
AI Spot	124	CAR	37	Fulgor	120
Algarve	9	Carrer	161	Galliot	182
Alin HT	144	Ceres Solar	178	Game	174
Alumina WP	147	CIM	26	Ghana	161
Andorra Adjustable	31	Ciutat	155	Graz	10
Aquos	145	Confort S Adjustable	17	Grill	39
Aquos Pro	145	Coridor E-S	80	Ground Round	154
AR78-LED Round	11	Coridor HN	85	Hadar	178
Arel	65	Coridor N-S	80	Haiti	158
Arel AS	65	Coridor NX	81	HBL	150
Arizona Downlight	20	Coridor S	81	Hol	19
Aros Double	78	CR	44	Hol Down	62
Aros Single	78	Cubic CCT	167	Holp	19
Aros Triple	78	Cyprus	169	Holp Down	62
Aros Wall	86	Datalux AC	141	Ibiza 15 sensor	61
Asta	65	Datalux LT	141	Ibiza 15/18/32	61
Atex Fiul	150	Datalux Next Gen	142	ID	42
Bangkok	22	Denmark 6	159	Infinity Air	75
BCN120 Air	71	Diogene	172	Infinity Air Direct-Indirect	75
BCN120 Down	55	Don X-Flip	27	Infinity Dot	68
BCN120 Track	118	Drac Round	24	Infinity Down	67
BCN30 Air	70	Drac Square	32	Infinity Down Dot	68
BCN30 Down	53	Draco	178	Infinity In Ceiling	38
BCN50 Air	70	Dubai 20	161	Infinity Wall Up/Down	85
BCN50 Down	53	Dubai 40 Up/Down	161	INL	47
BCN50 Track	117	Dublin	155	Innotrack	140
BCN90	59	Easy Fit Module	140	Innotrack Multifit	147
BCN90 Air	70	EB	43	Inot ICC	79
BCN90 Down	55	Ecolite F	91	Inot OCC	79
BCN90 Track	117	ED	46	Inox S GU10	16
Belgium	156	ED Rectangle	46	Inox S Round Orientable	17
Belize	169	EGO H2O	157	Inox S Round Orientable GU10	16
Benin	160	EK	42	Inox S Square Orientable	17
Benzin LED	150	EK Rectangle	42	Inox S Square Orientable GU10	16
Bergen	162	EPD	66	IR TR Louvre	127
Bogota 3F GU10	120	EPK	66	IR TR Opal	127
Bogota Pendant GU10	69	ES	45	IS	43
Bogota Round GU10	52	ES Rectangle	45	IS Rectangle	43
Bogota Spot GU10	58	Exa UFO	152	ISI	151
Bogota Square GU10	57	Eye	119	Ivo	166
Boston	24	Eye Down	58	Ivo Solar	182
Bow	163	EZ	39	Jamaica	169
Bow 1200	76	Fit IP65	47	Jupita	151
BOW 650	76	Flat AQ78-LED Square	14	Kale S/M/L/XL	168
		Flat AR35-LED Round	11	Kardan L	36

Kardan M	33	Nebira	180	QRailX Blind Cover	138
Kardan M Special	33	Neon 360 24V	104	QRailX Brackets	139
Kenya Switch	182	Neon Side 24V	104	QRailX Connector	139
Laos 12 Adjustable	23	Neon Top 24V	104	QRailX End Cap	139
Laos 12 deep Adjustable	23	Nepal	52	QRailX Module 4FT	131
Laos gen 2	22	Nepal 7 Round	52	QRailX Module 6FT	133
Latvia	64	Nepal 7 Square	55	QRailX Module 8FT	135
LED 24V Dimming	15	New Linje	128	QRailX Trunk Sensor	138
LED Driver	15-90	Norway Round	25	Quito	10
LED Floodstrip Dotfree	90	Norway Square	32	RH	149
LED Long Island 48V	97	Olympic 2	168	Romania	25
LED Multi	28	Oregon+	35	Ronda	157
LED Pipe	89	Oslo	162	RUA S/M/L	168
LED Strip 230V Pro	94	Owwl	50	SAN	29
LED Strip 230V Sagrada Familia	94	Owwl Surface	59	Serbia	154
LED Strip 24V Acropolis	100	Owwl Zoom	118	Shop Flat	128
LED Strip 24V Alhambra	96	Panama	167	Sintra	9
LED Strip 24V Big Ben TW	101	Paris	57	SKA SM	53
LED Strip 24V Branderburger TW	101	Passeig	162	SKA TR	122
LED strip 24V Brooklyn	99	Paw	30	Skadi Eco Spot	136
LED Strip 24V Brooklyn 67	95	Pin Bollard	171	Slender CC-S/S	79
LED Strip 24V Central Park RGB	101	Pisa	69	Slender DI	80
LED Strip 24V Colosseo	100	Placa	170	Slide Symmetric	125
LED Strip 24V Colosseo 66	94	Plate For Curved Diffuser	111	Slide Wallwash	125
LED Strip Driver 230V - 24V	102	Platinum Down	56	Slim Line Grazer	158
LED Strip 24V Golden Gate	96	Poland Gen 2	150	Slimlite CS LED	92
LED Strip 24V Notre Dame RGBW 67	95	Polar	148	SmartLED Flex 24V	103
LED Strip 24V Notre Dame RGBW	99	Pro N	28	SmartLED Flex 3D 24V	102
LED Strip 24V Petra RGBW	101	Pro SQ	33	SmartLED Lens 3D 24V	103
LED Strip 24V Picadilly Mini	99	Prodigy	184	Space	186
LED Strip 24V Times Square	97	Profile 45°	111	Sport 31	176
LED Strip 24V Trafalgar Square	96	Profile Alu 35mm	112	Square	56
LED Strip 24V Trafalgar Square Free Cut	97	Profile Alu Round	105	Square MCI	158
Libertad	21	Profile Alu Surface 180°	105	Step LED	184
Line Suspended	69	Profile Alu Tiber	109	Stockholm	170
Line Wall	86	Profile Asymmetric Wall	110	StormEX	147
Lithuania GEN 2	62	Profile Curved Embedding	108	Stuttgart	22
Lyon	166	Profile In Ceiling	108	Sutil	50
M-Line C	83	Profile Lean	107	Sutil Mini	51
M-Line CC	84	Profile LED Built-In	108	Sutil Mini TR	119
M-Line T	83	Profile LED Mounting	107	Sutil Mini Pro	51
Malva	152	Profile Low Recessed	111	Sutil Mini Pro TR	119
Megal	144	Profile Low Surface	112	Sutil Surface	60
Microline Grazer	93	Profile Magnetic	110	Sutil Mini Pro Surface	59
Micropolis	40	Profile Mini Recessed	107	Sutil Mini Surface	58
Mini line Grazer	93	Profile Nile	106	T-Max	149
Mini Round	187	Profile Okoa	105	Tectorum	62
Minic	180	Profile Surface Ceiling	109	Telly	151
Minim Single Air Up/Dwon Dot	74	Profile Surface High Performance	109	TIP	145
Mobile 1200	76	Profile Wall Up/Down	110	Tires down	61
Mobile 600	76	Pull Out	30	Tires I	72
Moon	186	Pull Out Mini	28	Tires II	72
MP	145	Pull Out Square	34	Tires III	72
Multi Wallpack	165	QN	46	Tires IV	72
NAN BI	35	QRailX	130	Tires V	73
NAN TR	124	QRailX 3F Track	138	Tokyo	118

Tolva	18
Tolva GU10	16
Tolva L Asymmtric	19
Tolva L Symmetric	18
Top Stick LED	88
Top Stick LED Asymmetric	88
Top Stick LED Sensor	88
Topo	27
TR ED	122
TR WED	122
Tripolis	40
TS	142
Twiggy Less	172
Twinlight	187
Ukraine	154
Unico Dicro GU10	120
Vali	120
Valo	81
Versailles	171
ViaLED Evo	185
ViaLED Evo Minibox	184
ViaLED IP65	185
Vienne 2	8
Vienna 5-10	8
Vlo	144
Vlok Down	163
Vlok Recessed	164
Vlok Wall	163
Vorona Switch	180
WED REC	50
WEDA SM	58
WRL	26
Zenit	178

## **Euro-Luce BV**

Ballingsweg 25  
BE - 9620 Zottegem  
Tel. +32 54 55 71 10  
[Info@euro-luce.be](mailto:Info@euro-luce.be)  
[www.euro-luce.be](http://www.euro-luce.be)